

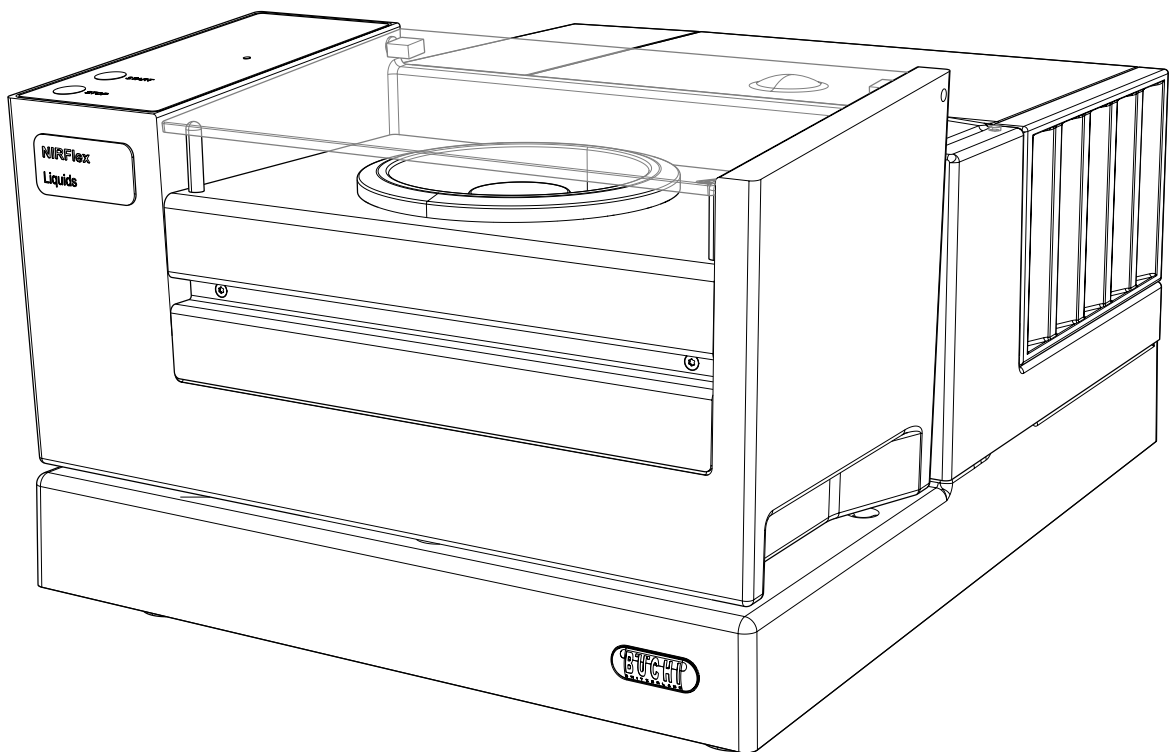

NIRFlex N-500

Technical data sheet

With its dedicated operator interchangeable measurement cells to accommodate many different sample types, the NIRFlex N-500 is a uniquely, flexible FT-NIR Spectrometer. Its Fourier Transform polarization technology guarantees the same superior performance across different environmental conditions; from laboratory to warehouse.



Scope of delivery

The following table depicts the most common package configurations by sample type and measuring mode.

	Basic Solids 001	Standard Solids 002	Advanced Solids 003	Basic Liquids 004	Standard Liquids 005	Advanced Liquids 006	Advanced Fiber Optic Solids 007	Advanced Fiber Optic Liquids 008	Advanced Solids Transmittance 010
NIRFlex N-500 Base Unit	●	●	●	●	●	●	●	●	●
NIRWare 1 Software CD incl. License Basic	●	●		●					
NIRWare 1 Software CD incl. License Advanced (CFR 21 Part 11)			●			●	●	●	●
NIRCal Calibration Software CD incl. License		●	●		●	●	●	●	●
NIRCal Toolbox CD incl. License		●	●		●	●	●	●	●
IQ/OQ Manual	●	●	●	●	●	●	●	●	●
Documentation Regulatory Compliance FDA/ EMEA			●			●	●	●	●

Measurement cell

Solids	●	●	●						●
Solids transmittance*									
Liquid				●	●	●			
Fiber optic solids							●		
Fiber optic liquids								●	

Add-Ons adapter

Petri dish	●	●	●						
Vial			●						
XL (irregular solid samples or transparent plastic bags)			●						
Tablet (reflectance measurement)			●						

*Sample plates should be ordered separately according to sample size and format

Order code

For assistance in choosing the right package, please contact your local BUCHI representative.



- 001 Basic Solids
- 002 Standard Solids
- 003 Advanced Solids
- 004 Basic Liquids
- 005 Standard Liquids
- 006 Advanced Liquids
- 007 Advanced Fiber Optic Solids
- 008 Advanced Fiber Optic Liquids
- 010 Advanced Solids Transmittance

Technical data

Base Unit*

Dimensions (W x D x H)	350 x 250 x 450 mm
Spectral range	800 - 2500 nm 12 500 - 4000 cm ⁻¹ (if not specified differently for measuring cell)
Resolution	8 cm ⁻¹ (with boxcar apodization)
Type of interferometer	Polarization interferometer with TeO ₂ wedges
Wavenumber accuracy	± 0.2 cm ⁻¹ (measured with HF gas cell at an ambient temperature of 25 °C ± 5 °C)
Signal-to-noise ratio	10000 (peak-to-peak noise of a linear corrected baseline)
Number of scans/sec.	2 - 4 (depends on resolution)
Type of lamp/lifetime lamp (MTBF)	Tungsten halogen lamp / 12000 h (2 x 6000 h)
Type of laser	12 VDC HeNe, wavelength at 632.992 nm
Analog digital converter	24 bit
Electric power supply	100 - 230 VAC ± 10 %, 50/60 Hz, 350 W
Ethernet connection	100 Mbit/s

*For a functional system a measurement cell is required

Measurement cells

NIRFlex Solids

Detector	Extended range InGaAs (temperature controlled)
Operating temperature	5 - 35°C

Sample holding accessories	Petri dish holder	Vial holder	XL* holder	Tablet holder
Sample dimensions	100 mm	10 - 15 mm	Adaptable	5 - 10mm
Illumination spot diameter	9 mm	8 mm	9mm	8mm

*Customized XL Flow Cell for measurement of liquids in transfectance available on demand. Functional principle

Background references applied	Petri dish holder	Vial holder	XL* holder	Tablet holder
Internal reference	●			
External reference	●	●	●	●
Max. number of samples per sequence	1	6	1	10
Measurement based on diffuse reflection**	●	●	●	●
Measurement based on transfectance**	●			

**See section "Measurement modes and setup"

Compatible with	Petri dish holder	Vial holder	XL* holder	Tablet holder
Petri dishes	●			
High performance cup	●			
Unbreakable cup	●			
Vials		●		
Tablets				●
Small plastic bags			●	

NIRFlex Liquids

Sample temperature range	Ambient temperature plus 10 °C up to 65 °C
Reproducibility of set sample temperature	± 0.5 °C
Temperature overshoot	< 5 °C
Overheating protection, automatic switch-off	T > 90 °C
Detector	Extended range InGaAs (temperature controlled)
Diameter of measurement spot	2 mm
Type of cuvettes to be used*	Cuvettes 12.5 x 12.5 x 45 mm with path lengths of 1, 2 (standard), 5, and 10 mm using corresponding spacers

NIRFlex Liquids

Time needed to achieve stable control of the set temperature	Ambient temperature to 65 °C: 15 min
--	--------------------------------------

* Disposable monouse glass vials available

NIRFlex Fiber Optic Solids/ Liquids/SMA

	Fiber Optic Solids/ SMA	Fiber Optic Liquids
Temperature range at probe tip	0 °C – 80 °C	0 °C – 150 °C
Max. pressure at the probe tip		6 bar
Detector	Extended range InGaAs (temperature controlled)	
Standard lengths of fiber optic probes	2 m, 3 m, 5 m*	2 m (available up to 7 m)
Path length	0.5 mm, 1.0 mm, 1.5 mm* (with transreflectance adapter)	2 mm (other path lengths available on request)
Number of optical fibers	> 560 (fiber bundle)	2 (single fiber)
Outer diameter of optical fibers	4 mm	600 µm
Time needed to achieve stable control of the set temperature	Ambient temperature to 65 °C: 15 min	

* Path length and length of glass fiber of SMA probes are customizable at convenience

Transreflectance adapter

Max. operating temperature	120 °C
Material	Steel no. 1.4435
Transreflectance adapter window	Quartz glass (Infrasil 303)
Available path lengths (x2)	0.5 mm, 1.0 mm, 1.5 mm

NIRFlex Solids Transmittance

Detector	InGaAs (temperature controlled)
Spectral range	12 500 – 6000 cm ⁻¹ 800 – 1660 nm
Photometric dynamic range	0 – 6 AU
Photometric linearity	Tested by certified NIST standards (rare earth oxide mixture)
Typical signal-to-noise ratio	RMS for spectral segments of 300 cm ⁻¹ in the range of 11 000 – 6500 cm ⁻¹

Measurement cells and accessories

The following table depicts the most common accessories by sample type and measuring mode. Please contact your local BUCHI representative for more options.

Measurement cells		Order code	Picture
NIRFlex N500 Base Unit	NIRFlex Interferometer incl. NIRWare Basic License	N505-003	①

Measurement cells		Order code	Picture
NIRFlex Solids	Measurement of solid, cream and liquid samples in reflectance or transreflectance mode*.	N510-000	②

Add-Ons NIRFlex Solids		Order code	Picture
Petri Dish holder	Measurement of solid, cream and liquid samples in petri dish, high performance cup or unbreakable cup.	N510-001	③
Vial holder	For measurement of solid samples using glass vials.	N510-002	
XL holder	Measurement of liquid samples in transreflectance or solid samples in diffuse reflectance trough plastic bags or different kinds of sample cups.	N510-003	
Tablet holder	For measurement of tablets.	N510-004	
Set of 10 petri dishes	Schott optical glass cups for routine use	41583	⑥
High Performance Sample Cup	Tightly specified glass for optimized signal reproducibility	46259	
Unbreakable Sample Cup	Silicone rubber rim and hardened glass for production environment	11055058	⑦
Pressing Stamp	To compress and compact samples like ground meat or cheese. Stainless steel, approx. 1.8 kg.	11057584	⑧
Transflectance cover	For measuring liquid samples in transreflectance with a thickness of 0.3 mm. To be used with high performance cup Order code 46259.	041636	
Transflectance cover for the unbreakable cup	For measuring liquid samples in transreflectance with a thickness of 0.3 mm. To be used with unbreakable cup Order code 11055058.	11055998	⑨

		Order code	Picture
NIRFlex Liquids	Measurement of clear liquids in transmission mode.* Possibility to work with cuvettes of 1, 2 and 5 mm path lengths, as well as disposable vials with 8mm diameter.	N511-000	

Add-Ons NIRFlex Solids		Order code	Picture
Quartz cuvettes	Set of 2 quartz cuvettes with 2 mm path length.	046266	
Vials	Set of 100 disposable vials with 8 mm outer diameter.	49889	

Add-Ons NIRFlex Fiber Optic Solids		Order code	Picture
NIRFlex Fiber Optic Solids	On-site raw materials control for powders, granular materials, solids and creams in diffuse reflection mode, as well as liquid samples in transfectance mode. Fiber optic length: 2 m default (3 and 5 m available on request).	N512-000	
Transflectance adapter	Open sleeve accessory for measurement of liquid samples with Fiber Optic Solids Order code N512-000.	N512-006	

		Order code	Picture
NIRFlex Fiber Optic Liquids	On-site measurement of liquid samples in transmission mode (2 mm pathlength). Resistant to highly corrosive liquids.	N513-000	

		Order code	Picture
NIRFlex Solids Transmittance	Measurement of solids samples like tablets, capsules and powders in diffuse transmission. Various sample plates are available to accommodate a wide range of tablet sizes and shapes. The plate needs to be ordered separately.	N514-000	

		Order code	Picture
NIRFlex Fiber Optic SMA	Cell for reflectance as well as transmission measurement. Requires probes and fiber optic cables to be ordered separately.	N515-000	

*See section "Measurement modes and setup"

Accessories pictures

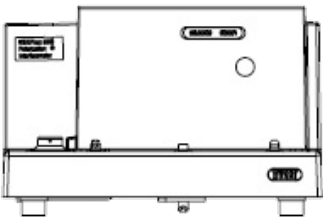

1

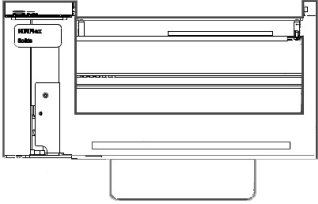

2

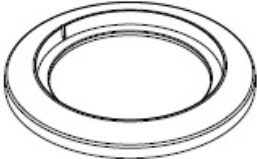

3

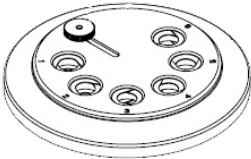

4

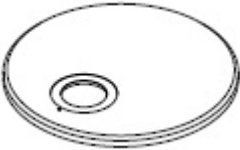

5

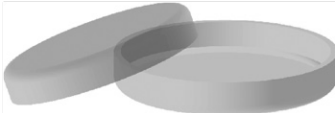

6

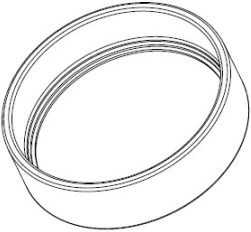

7

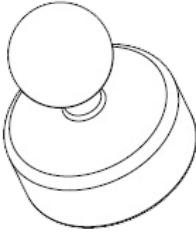

8

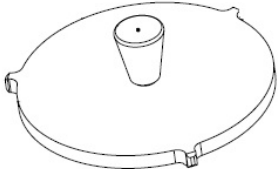

9

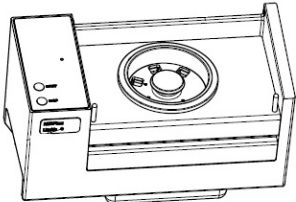

10

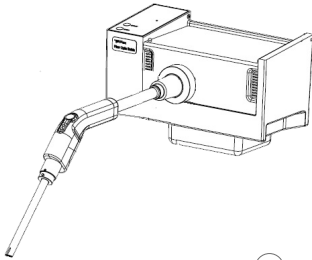

11



12

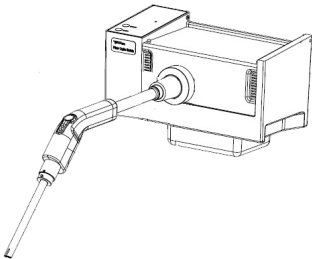

13

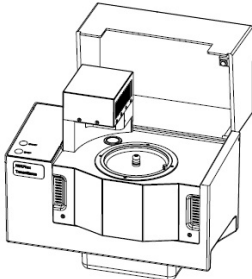

14

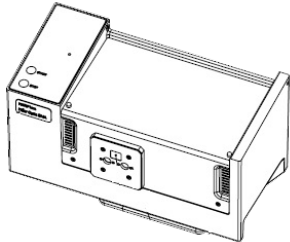

15

Functional principle

The NIRFlex is a benchtop Fourier Transformation Near Infrared spectrometer (FT-NIR) to identify and quantify analytes of interest. It generates an invisible near infrared interferogram beam which interacts with the molecules of a sample, generating a characteristic feedback. The feedback is picked up via a measurement cell by a detector and mathematically processed via Fourier transformation into a spectrum. This spectrum is characteristic for a given sample and allows identification as well as quantification of its components.

How the interferogram is generated

An interferogram is an interference pattern of phase-shifted beams. The NIRFlex is a single-beam polarization interferometer, generating its interferogram in four steps:

Step 1: Polarization of the light source output

The polarizer ② generates a well-defined polarization output of the undefined polarized light, emitted by the light source ①. Thus, only diagonally polarized light is transmitted.

Step 2: Beam splitting and orthogonal polarization

The polarized light enters a double refracting block (comparator) ③. Here, the light is broken down into two, orthogonally polarized components with a small, static phase shift.

Step 3: Generating the ongoing phase shift

An assembly of two double refracting wedges is arranged after the comparator. Wedge ④ is stationary, while wedge ⑤ is constantly shifted back and forwards by a fast linear-drive. The movement and the geometric arrangement provides a change of thickness in the light path. This leads to an ongoing phase shift between the light beams.

Step 4: Beam recombination and interferogram output

A second polarizer ⑥ converts the phase shifted beams into a single light output with intensity variation – the interferogram

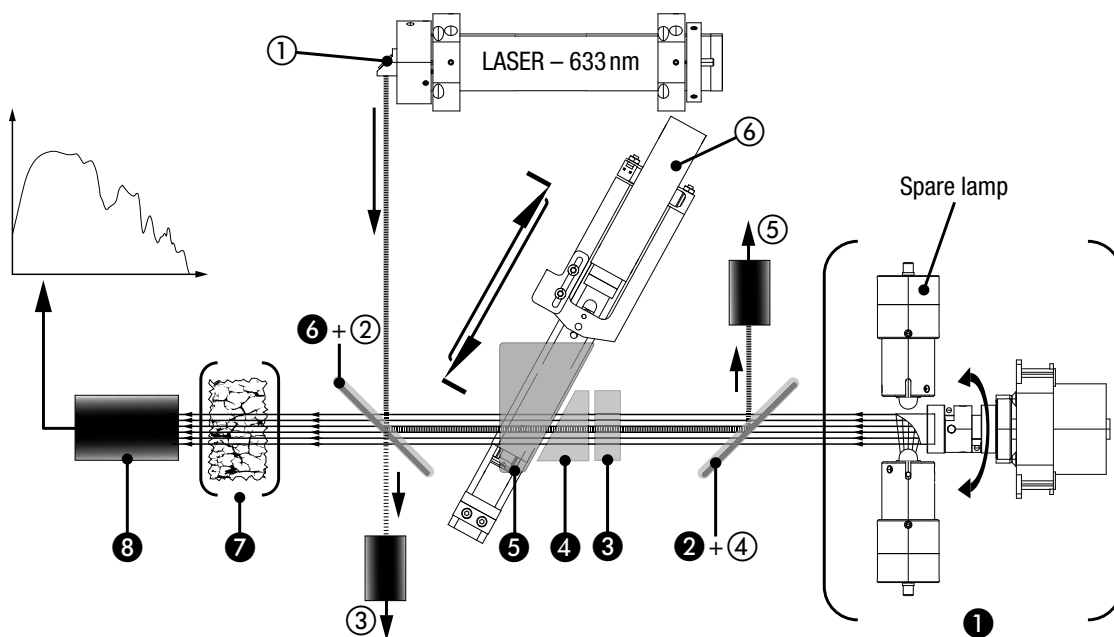

Effective NIR light path

- ① NIR light source assembly with spare lamp and motorized parabolic reflector
- ② First polarizer
- ③ Comparator (double refracting block)
- ④ Stationary double refracting wedge
- ⑤ Moving double refracting wedge
- ⑥ Second polarizer
- ⑦ Sample
- ⑧ Interferogram detector

Reference laser signal path

- ① Laser output window
- ② Second polarizer (works as a beam splitter for the laser)
- ③ Laser output-power sensor
- ④ First polarizer
- ⑤ Laser feedback detector
- ⑥ Linear motor for wedge movement

Measurement modes and setups

At the NIRFlex, different measurement setups can easily be attached to the basic instrument to meet the individual sample requirements. To choose the best setup for a specific range of samples the optical properties of the sample material must be known.

Measurement mode	Description	Typical application
Diffuse reflection	Most non-translucent materials (e.g. solids such as powders, pellets and cereals) can be analyzed via diffuse reflection. The NIR light penetration is limited by the sample material. It interacts with the sample, is refracted and diffusely reflected into the sensor. The reflected rays contain the spectral information of the sample.	Predominantly non-translucent solids such as powders, pellets and cereals

Measurement mode

Description

Typical application

Transflectance

Translucent and opaque liquids can be analyzed via transflectance mode. The light penetrates the liquid, is diffusely reflected by the reference plate and passes the sample a second time. The transflected rays contain the spectral information of the sample.

Liquids with weak diffuse reflection and medium transmission rate characteristics (e.g. transparent to opaque liquids or sludge)

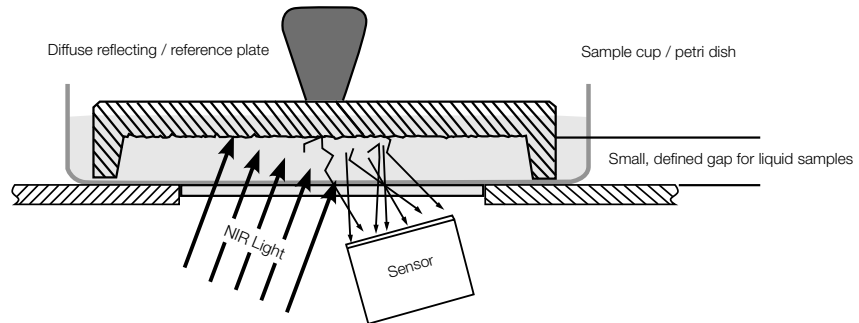

Transmission

NIR light is sent through a defined path length of sample material (e.g. in a cuvette). The transmitted light contains the spectral information. This is the preferred method for testing liquids.

Translucent and transparent liquids

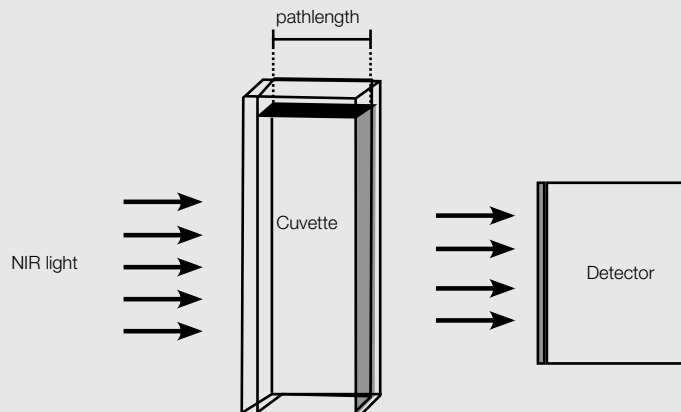

Diffuse transmission

The diffuse transmission mode is a mixture of “diffuse reflection” and “transmission” mode. The NIR light penetrates the sample:

Such as some tablets, crystal powders and other light conducting materials

- is refracted
 - diffusely reflected
 - diffusely transmitted
- The transmitted rays contain the spectral information of the sample.

