

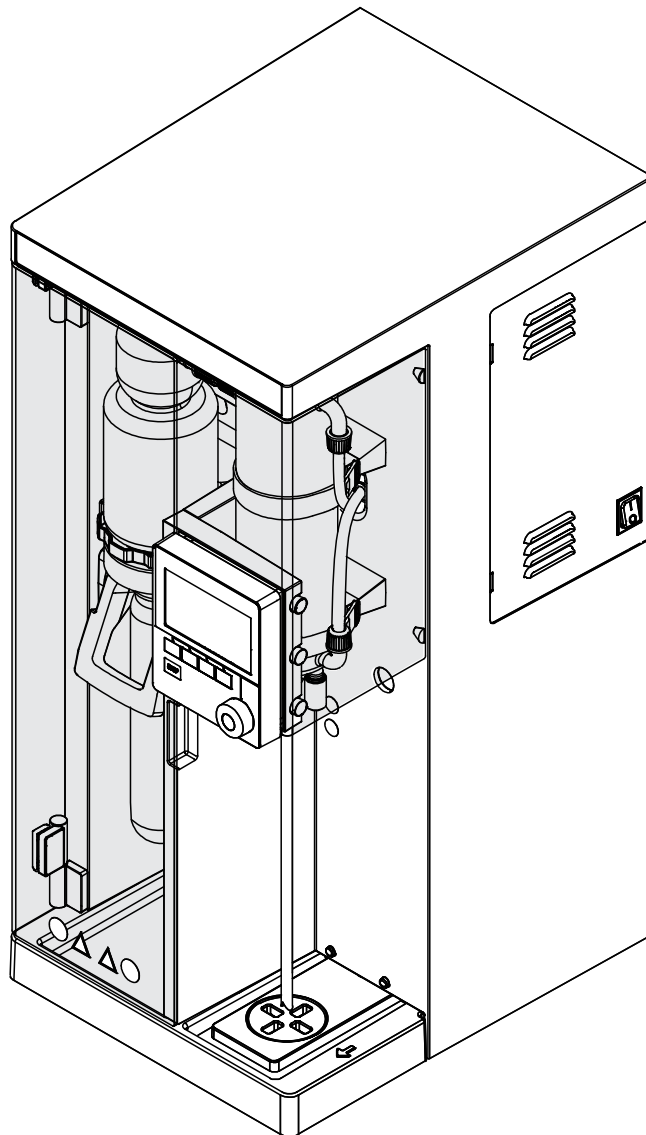

K-365 DIST-800

Technical data sheet



Scope of delivery

	K-365 DIST-800
Instrument	1
BUCHI Bluetooth® Dongle	1
Suction tube tank	1
Hose for water feed (2 m)	1
Hose for cooling water drain (3 m)	1
Pair of glass tongs	1
Hose for instrument drain	1
Flexible condensate outlet tube	1
Hose clip D11.9	2
Declaration of conformity	1
Hose clip D10.7	1

Order code

1 1 K 3 6 5 1 2 4 4 0

Technical data

K-365 DIST-800

	K-365 DIST-800
Dimensions (W x D x H)	320 x 400 x 730 mm
Weight	23 kg
Connection voltage	220 - 240 ± 10 % VAC
Power consumption	2100 W
Frequency	50 / 60 Hz
IP Code	IP20
Pollution degree	2
Overvoltage category	II
Tap water pressure	1 - 10 bar
Tap water condition (If the temperature is more than 25°C use a recirculating chiller)	1- 25°C
Tap water consumption	~ 1.2 L/min
Approvals	CE, CSA

Instrument specifications

	K-365 DIST-800
Distillation capacity (100%)	~ 40 mL/min
Distillation capacity (100%) with 200 ± 10 % VAC	~ 32 mL/min
Ready pressure steam generator	900 hPa
Adjustable distillation power	10 - 100%
MaxAccuracy Mode (Compensation of power grid fluctuations)	Yes
Distillate reproducibility (RSD) (At 300 seconds distillation time)	<1%
Safety sensors	Yes

Interface specifications

Display	LCD color, 4.3 in
Control elements	Buttons / control knob
Max. number of methods	8
Max. number of determinations	36
Max. number of determinations per series	16
Max. number of templates	4
Max. number of users	4
Max. number of determination results	40
Language	en, de, fr, it, es, pt, ja, zh, ru, pl, ko, id

Ambient conditions

For indoor use only.

Max. altitude above sea level	2000 m
Ambient and storage temperature	5–40 °C
Maximum relative humidity	80% for temperatures up to 31 °C decreasing linearly to 50 % relative humidity at 40 °C

Materials

Component	Materials of construction
Housing	Polyurethane
Housing electric	Stainless steel
Steam generator housing	Stainless steel
Rear cover	Polyvinyl chloride
Glass parts	Borosilicate 3.3
Protective cover	PMMA
Sealing	EPDM

Spare parts and accessories

Condenser spare parts

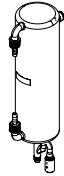
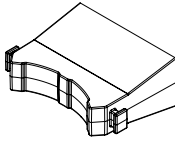
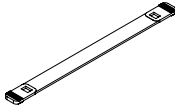
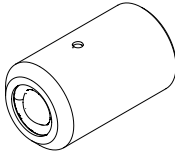
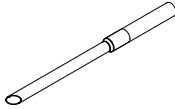

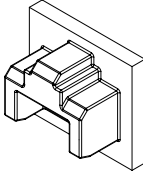
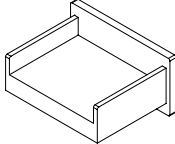

	Order no.	Image
Condenser with check valve	11072183	
Clamp for condenser	11066868	
Rubber band	11070669	
Check valve	11071740	
Flexible condensate outlet	11069205	

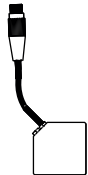
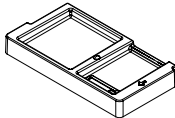
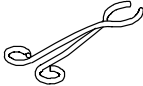
Other spare parts

	Order no.	Image
Cap RJ-45 cap	11055949	
USB cover	11069375	

	Order no.	Image
Level sensor capacitive	11065245	
Tank level sensor (Velcro point)	11070517	
Tank level sensor (Velcro strap)	11070516	
Silicone hose D6/9 L=3 m	048355	
Collecting pan	11066465	
Pair of glass tongs	002004	

Sample tubes

	Order no.	Image
Sample tubes 300 mL 20 pcs.	11059690	
Sample tubes 300 mL For sample volumes up to 200 mL or 5 g in weight 4 pcs.	037377	
Sample tubes graduated 300 mL 4 pcs.	043049	
Sample tube 500 mL	026128	
Sample tubes 500 mL 4 pcs.	043982	

Splash protector spare parts

	Order no.	Image
Glass splash protector (EasyDist)	11071015	A cylindrical glass splash protector with a top cap and a side outlet.
Plastic splash protector (EasyDist)	11072055	A cylindrical plastic splash protector with a top cap and a side outlet.
Sealing sample tube to splash protector (acid resistant)	11063243	A circular, flanged sealing ring.
Steam inlet tubing to sample tube	043424	A thin, straight tube.
Connecting piece EPDM	11062478	A tapered, conical connecting piece.
Bridge splash protector to condenser	11070620	A cylindrical bridge splash protector with a textured surface.
Cap nut GL14	033577	A large, flanged cap nut with a textured surface.
Hose barbs. set. 4 pcs, straight, GL14, FPM seal Content: Hose barbs, cap nuts, seals.	040296	A set of four small hose barbs, cap nuts, and seals.
Seals, set. 10 pcs, for hose barbs GL14, FPM, green	040040	

Maintenance kits

	Order no.
Preventive maintenance kit	11073067
Customer Kit for Dist Line	11073025

Cable and tubing

	Order no.
Hose to NaOH/ H ₂ O/H ₃ BO ₃ pumps or drain (2 m)	11072687
Hose clip to NaOH/H ₂ O/ H ₃ BO ₃ pumps or drain	043841
Suction to tube tank (0.58 m)	043407
Silicone hose D6/9 L=3 m	048355

Accessories

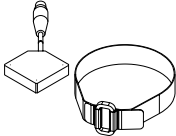
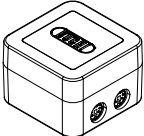
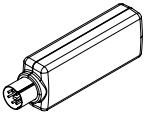
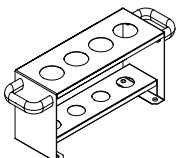
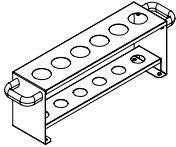
	Order no.	Image
Tank level sensor kit	11072294	
StatusLight cpl., incl. communication cable Indicates the status of the instrument (instrument is ready to use, has an error or is in operation).	11068959	
BUCHI Bluetooth® Dongle, connects instrument to smart-phone via Bluetooth®	11067770	
Sample tube holder (4x 500 mL tubes)	016951	
Sample tube holder (6 x 300 mL tubes)	043039	
Sample tube holder (12 x 300 mL tubes)	043041	