

Solutions for the chemical industry
Real-time process control

NIR-Online®

Industry-proven design

Compact, robust design without moving parts handles rough conditions like vibrations, extreme temperatures, wind or humidity.

Diode array technology

High-speed measurements of fast-moving goods.

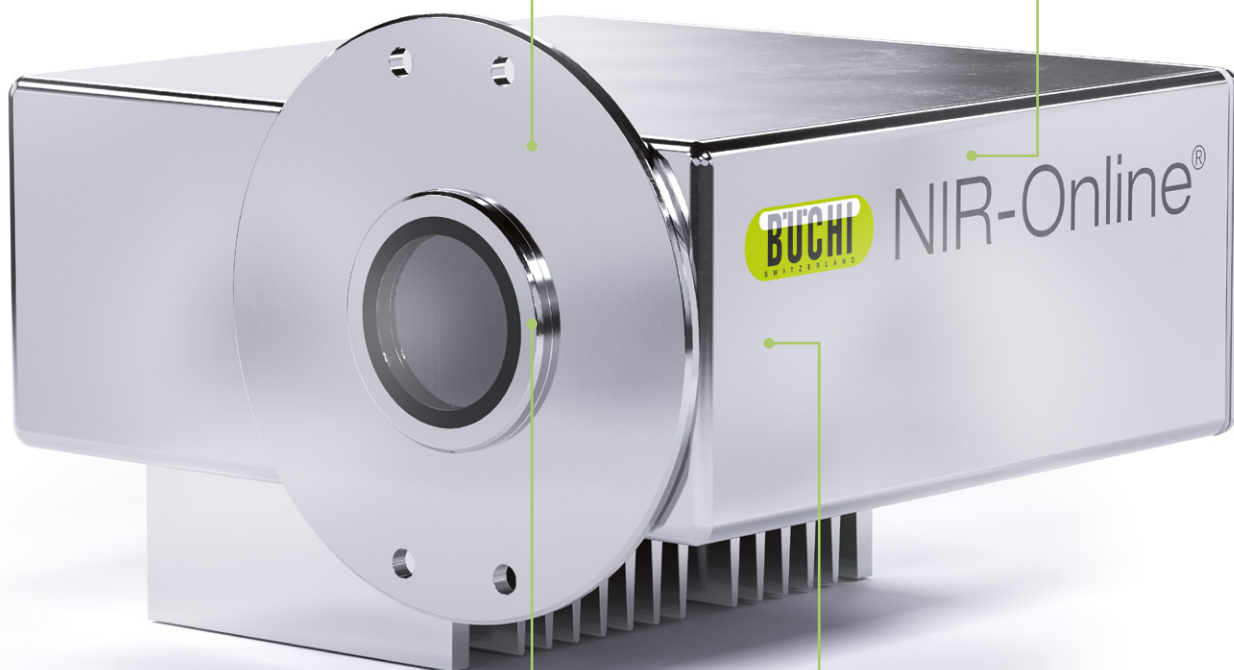

Dual lamp

Maximum system availability through automatic switchover to a secondary light source.

ATEX certified

Certified for utilization in potentially explosive gas and dust atmospheres. Superior safety at all times.

NIR-Online Solutions

Main benefits along your value chain

BUCHI NIR-Online® Solutions enable enhanced productivity and higher quality for maximum gross profit margins. We support you in optimizing all stages of production – from incoming goods inspection to releasing finished products and everywhere in between.



Certified safety
for hazardous environments

BUCHI NIR-Online® Solutions for the chemical processing industry ensure safe operation in potentially explosive environments. The NIR-Online Process Analyzer is designed and certified to be used in zones 0 and 1 together with an additional enclosure and for zone 2 in direct contact with a product. You benefit from full installation flexibility, as additional explosion-proof cabinets are not required. Moreover, our Gas-Ex solutions are fully compatible with our large process integration portfolio.



Multiple measurement options
All parameters with one sensor

NIR-Online is the only supplier to combine the benefits of NIR, VIS and a high-resolution camera in an "all-in-one" analyzer dedicated to meeting your needs. This unique combination enables simultaneous measurements such as moisture, chemical composition, and color as well as visual monitoring of the process streams in the chemical industry.



Ease of use
Operator-friendly with unique AutoCal functionality

AutoCal is the most convenient tool available on the market for inserting a reference value directly into an existing calibration and for recalculation according to the measurement data. No export/import functions, no manual calibration routines or extensive background in chemometrics are required. With AutoCal you eliminate the need to develop extensive in-house calibrations or purchase calibration databases.

Chemical Applications & Industries

The best solution for your needs

Our broad spectrum of turnkey solutions for the chemical industry meets the demands of your applications and covers products like wood and pulp, polymers, petrochemicals, and personal care products, among others.

Consumer Care



- Active Detergents
- Additives
- Color
- FFA
- Glycerin
- Moisture
- OH Number
- Peroxide Value
- Viscosity

Polymers



- Acid Value
- Additives
- Amine Value
- Color
- Diethylene Glycol
- Epoxy Numbers
- Isocyanate (NCO)
- Isophthalic Acid
- Melting Point
- Moisture
- OH Number
- Peroxide Value
- Viscosity

Fertilizers



- Conductivity
- Matter
- Magnesium
- Moisture
- Nitrogen
- pH
- Phosphorus
- Potassium

Wood & Paper



- Adhesives
- Ash
- Cellulose
- Coatings
- Color
- Density
- Lignin
- Moisture
- Pigments
- Waxes

Biotechnology



- Cell Count
- Cell Viability
- Enzymes
- Glucose
- Glutamic Acid
- Glutamine
- Lactate
- Metabolites
- pH
- Protein
- Turbidity
- Viscosity

Ink & Paint



- Color
- Iodine Value
- Moisture
- Pigments
- Solvents
- Thickness
- Viscosity

Petrochemicals

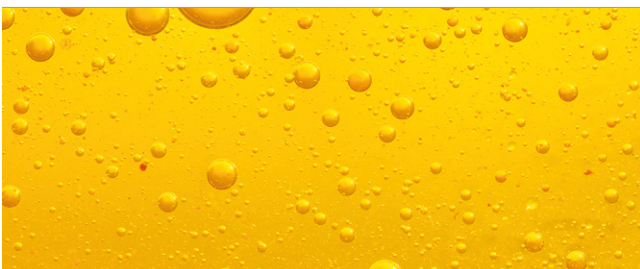

- Cetane Number
- Cloud Point
- Color
- Density
- Ethanol
- FFA
- Glycerides
- Glycerin
- Iodine Value
- Moisture
- Octane Number
- Peroxide Value

Construction Materials



- Al_2O_3
- Alite
- Aluminate
- Anhydrite
- Ash
- Belite
- Calcite
- CaO
- Chlorine
- Crystal Water
- Fe_2O_3
- Gross Calorific Value
- Gypsum
- Hemihydrate
- K_2O
- Moisture
- Na_2O
- Net Calorific Value
- PbO
- SiO_2
- SO_3
- Sulphur

Incoming goods inspection

For bulk and pumpable goods, liquids, granules, and solids

The installation of a BUCHI NIR-Online® Process Analyzer just before the different silo compartments enables efficient incoming goods characterization and segregation for optimal use and traceability. Real-time information is automatically transferred to a control room and enables automatic quality segregation based on pre-set criteria, thus optimizing subsequent production steps and saving costs.

Load-out to silo – for pumpable goods & liquids

Qualification of liquid raw material directly in the pipe.

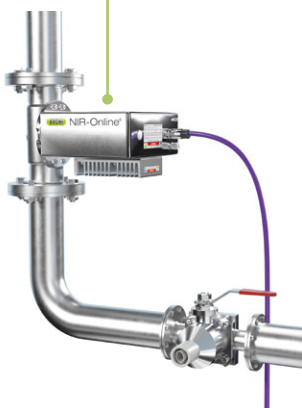

Key facts:

- Flow-through cell enables easy integration into the pipe section between truck and silo
- Designed to be used in Gas-Ex zones according to the ATEX directive

Gate control – for granules & solids

Raw material quality is monitored directly in the truck unloading area.

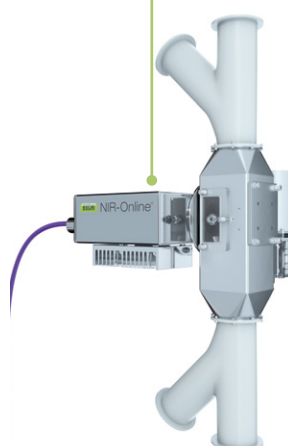

Key facts:

- Automated measurement process
- Real-time information on the true average value of the critical quality parameters

With the installation of a BUCHI NIR-Online® Process Analyzer in the truck unloading area, true average values of the critical quality attributes are determined in real-time and allow a decision upon acceptance or rejection of the incoming goods.

Big Pack

Bulk solids delivered in big packs are inspected in real-time.

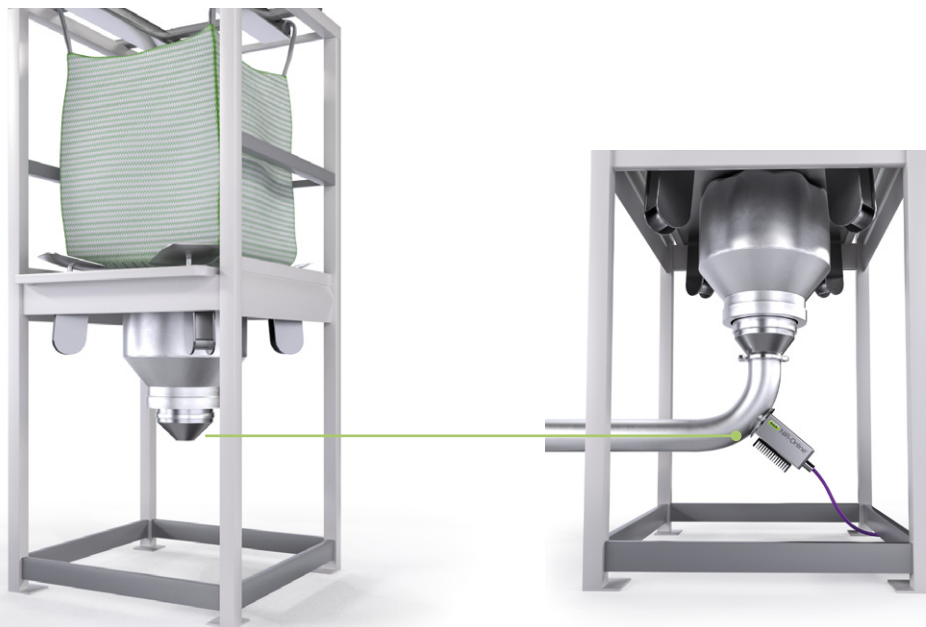

Key facts:

- 100% traceability of the material quality
- True average values for each delivery
- Raw material can be released in real-time

Process optimization for reaction control

Real-time monitoring of polyurethane manufacturing process

Polyurethanes are plastics that result from the polyaddition reaction of polyols with polyisocyanates. The efficiency syntheses process and quality of polyurethanes depend heavily on the raw material, intermediates, and composition. The NIR-Online Process Analyzer can be used for real-time monitoring of essential parameters in various process steps. This enables the determination of process-critical parameters such as NCO or water content, allowing immediate in-process adjustments and closer-to-target production.

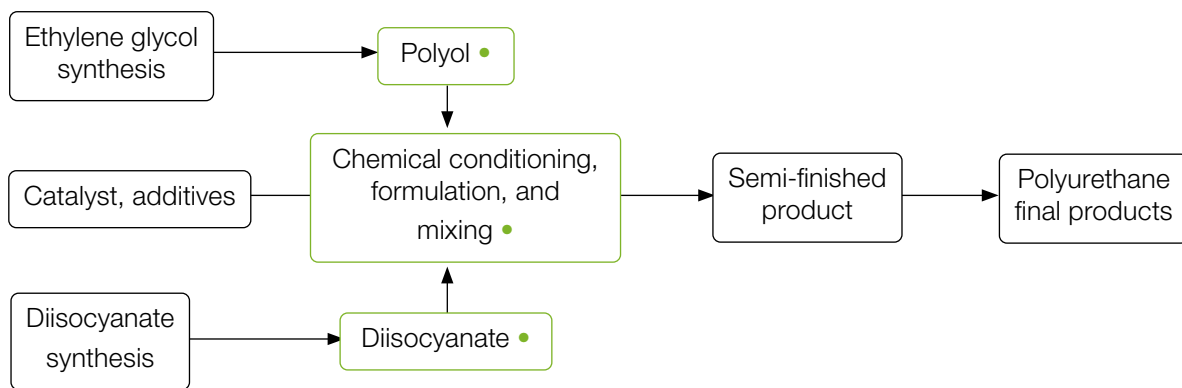

- NIR-Online applications & installation points

Example of Isocyanate (NCO) concentration versus process time.

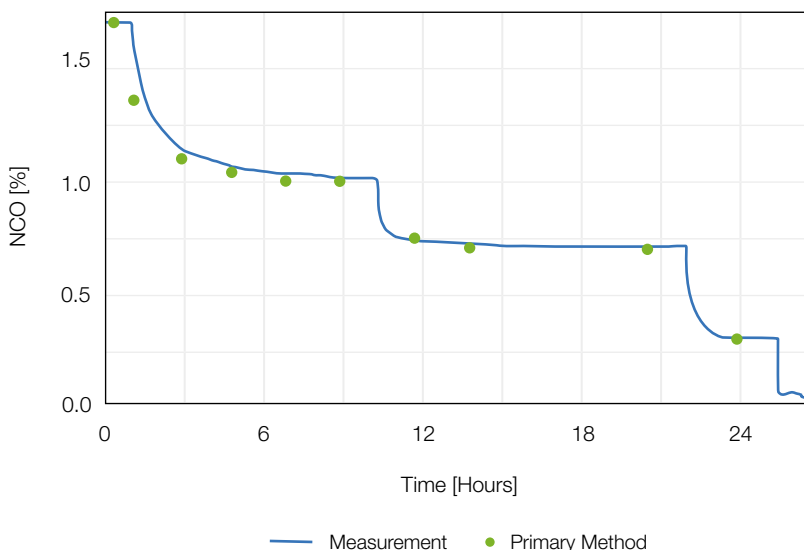

Key parameters by NIR-Online:

- Amine concentration
- Isocyanate conversion rate and moisture
- OH number of polyol and ethylene glycol
- Monitoring of polyurethane elastomer curing
- Acid, base number, and water content in polyols
- Catalyst, additives, and pigments concentration

Implementation in the reaction and mixing tanks

The Weld-In Flange allows use in rugged industrial environments directly in the process vessels. The X-Cell or Varinline® Adapter permit optimal integration of the sensors into the existing piping system. The standard product line encompasses a wide range of sizes and optical pathlengths. On request, we develop, design, and provide a perfect solution for almost any application.

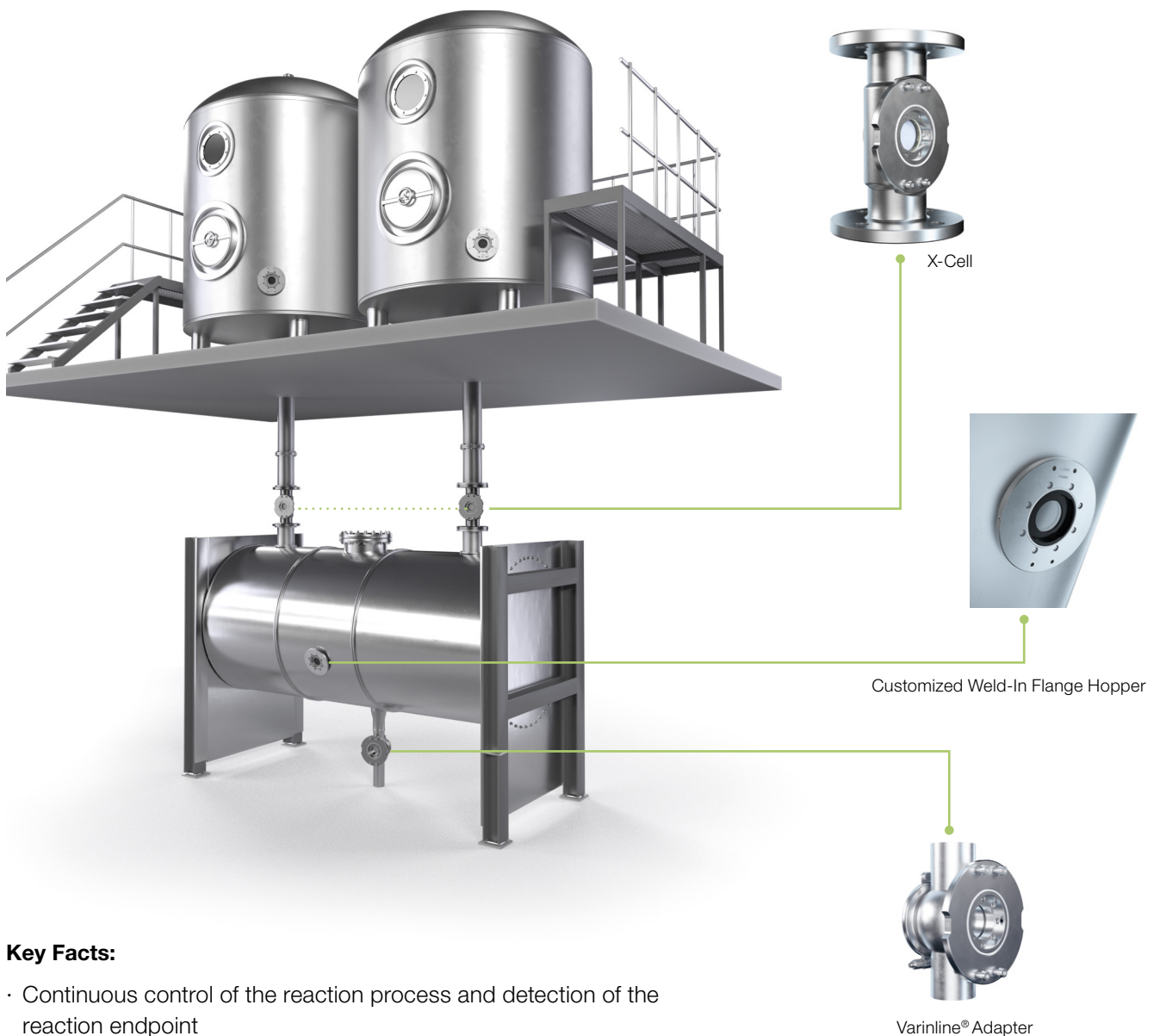

Key Facts:

- Continuous control of the reaction process and detection of the reaction endpoint
- Process issues and inhomogeneities can be detected much easier due to the higher spatial resolution of the measurements compared to grab sampling
- Designed to be used in Gas-EX zones according to the ATEX directive

Process optimization for the polymer industry (PET)

Real-time monitoring of PET

PET comes from polyester polymer melt. Different applications, such as for fibers, films, and bottles, require different degrees of polymerization, which can be achieved by modifying the process conditions. One relevant process parameter for the product characterization is the molecular weight of PET, which is measured by solution viscosity. Intrinsic viscosity, known as IV, is a widely applied method. NIR-Online analyzers measure IV and other parameters of the finished PET resin in real-time, enabling reliable process control.

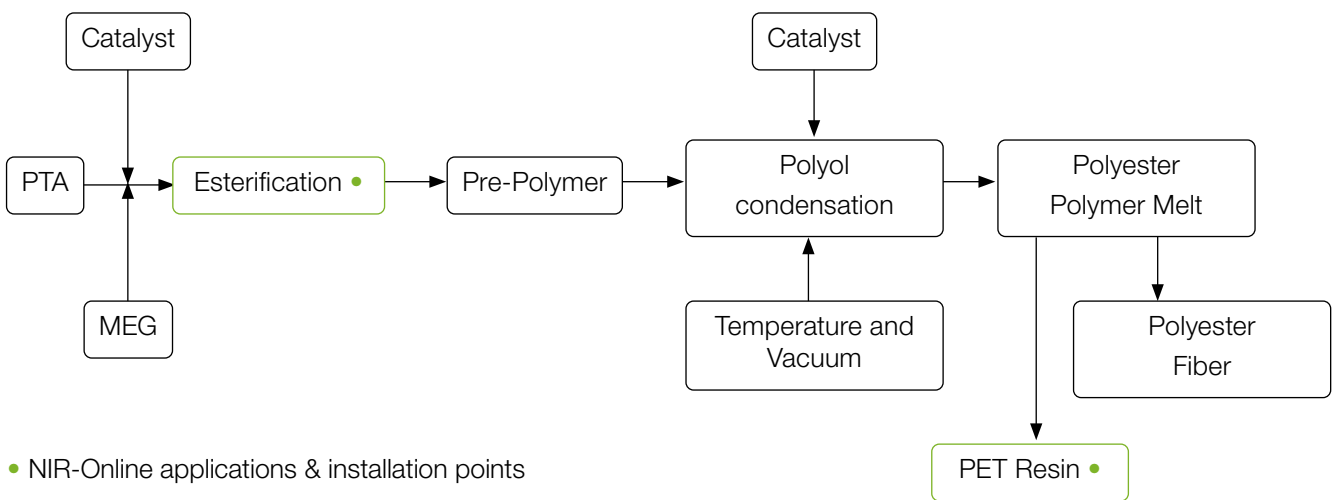

Example of a transition period from “bottle-grade” PET with IV near 0.85 to “textile-grade” with values closer 0.6. NIR trending plotted against reference samples.

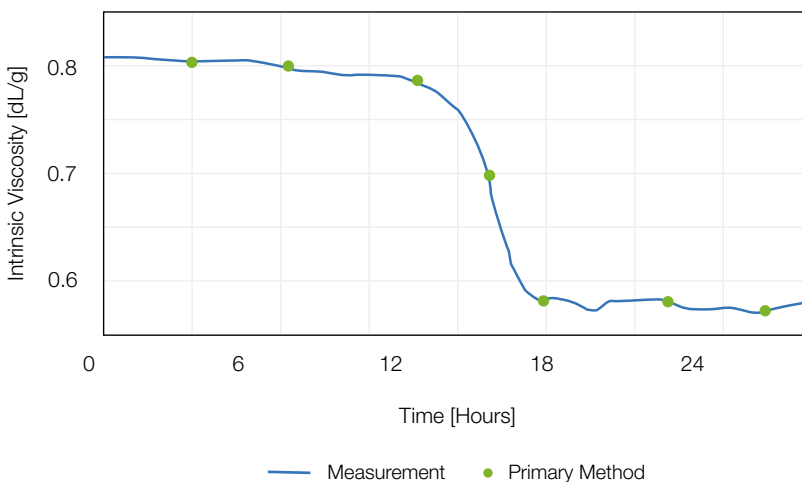

Key parameters by NIR-Online:

- Intrinsic viscosity (IV)
- Diethylene glycol (DEG)
- Isophthalic acid (IPA)
- Acetaldehyde (AA)
- Melting point (MP)
- Color (L, a, b)
- Visual inspection (camera)

Implementation right to the main line

A process analyzer integrated into the main line of the finished PET resin monitors key parameters including IV and color.

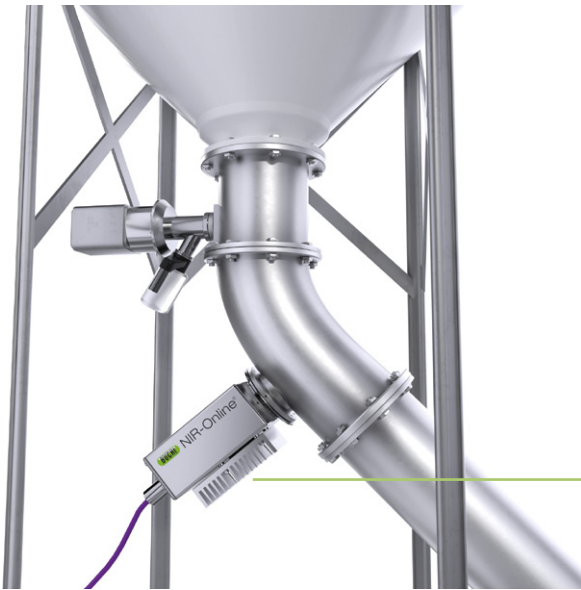

Key facts:

- A wide range of process adapters allows easy integration into production lines, including pipes, chutes, hoppers, and vessels
- Real-time information provided by the NIR-Online Process Analyzer is automatically transferred to a process control system

Installation by going bypass

Optimal product presentation is achieved with a bypass sampler maximizing sensor performance.

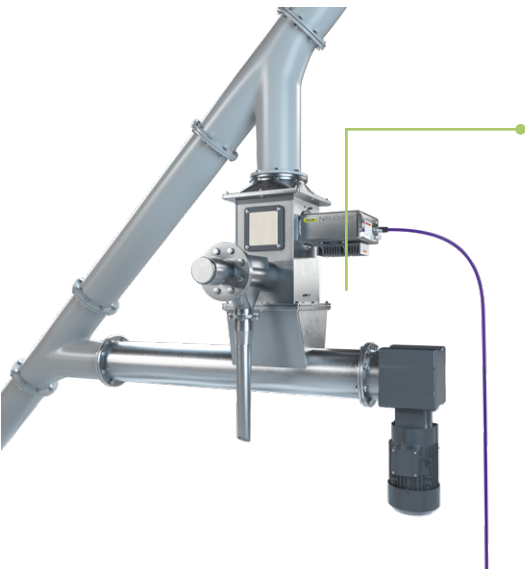

Key facts:

- Bypass sampler enables measurements along sections of pneumatic conveying with low product density
- It enables use of built-in CCD camera for the visual inspection and documentation of the finished PET resin

Process optimization for chemical mixing

Ensuring product homogeneity in real-time

Mixing is a common operation in industrial chemical engineering that involves manipulation of a heterogeneous physical system with intent to make it homogeneous. Blending of solids can be controlled in real-time by mounting a wireless NIR-Online sensor on the top of the bin blender. Similar types of dynamic mixers are used for powder blending. The homogeneity end-point will be determined in real-time and automatically stops the blending process. With static mixers, the sensor will be flanged on the side of the product chamber for optimal signal quality. The fluid-bed drying and granulation process can be controlled in real-time for optimal processing and end-point determination.



- NIR-Online Applikationen & Installationspunkte

Key parameters by NIR-Online:

- Moisture
- Homogeneity
- Active ingredient

Example of homogeneity end-point determination.

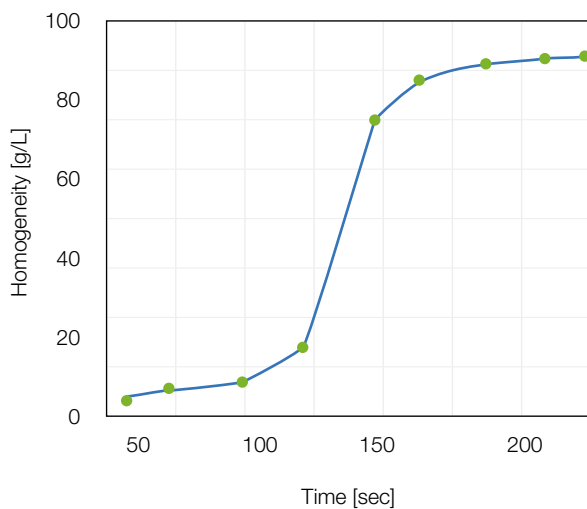

Example of moisture determination.

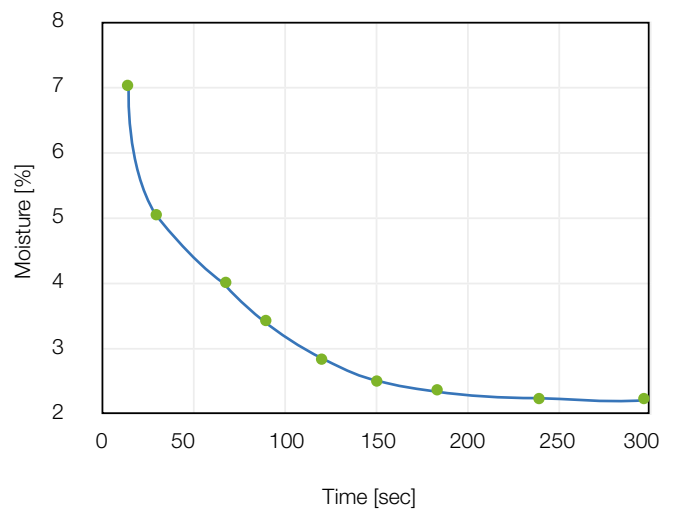

— Measurement • Primary Method

Weld-In Flange installation

The NIR-Online sensor is flanged on the side of the static mixer or on the product chamber of the fluid-bed dryer.

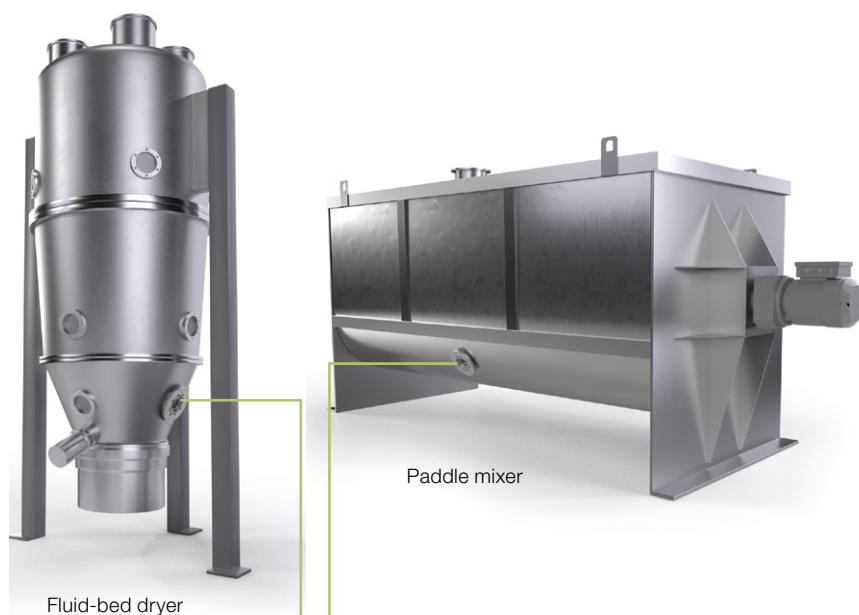

Key facts:

- Active ingredient(s), excipients, moisture content, and homogeneity can be determined in real-time for optimal processing
- For monitoring moisture in real-time during drying or granulation process

Bluetooth installation

An NIR-Online wireless sensor with Bluetooth interface is mounted on the top of the bin blender.

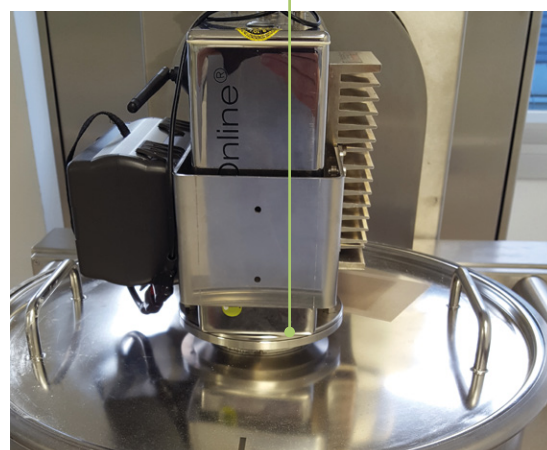

Key facts:

- Relative homogeneity of 99% indicates that the blend is homogeneous
- Automatic stop of the blending process when relative homogeneity is achieved

Process optimization for biotechnology

Real-time monitoring of fermentation

Biotechnological processes represent a complex engineering process that uses whole living cells or their components including bacteria, enzymes, and chloroplasts to obtain the desired products. NIR-Online analyzers can be used for real-time monitoring of important parameters at different process steps. They enable the determination of process-critical parameters such as pH, cell concentration, or conversion and degradation rates of nutrients. This allows immediate adjustments during the process and production closer to targets.



- NIR-Online applications & installation points

Fermentation process steps

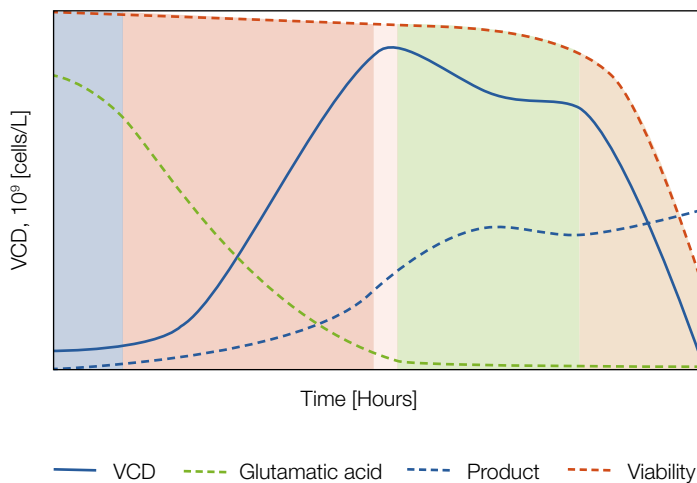

A typical batch growth curve includes the following 5 phases:

- (1) Lag phase
- (2) Logarithmic or exponential growth phase
- (3) Deceleration phase
- (4) Stationary phase
- (5) Death phase

Example of glutamatic acid concentration during 18 h fermentation process.

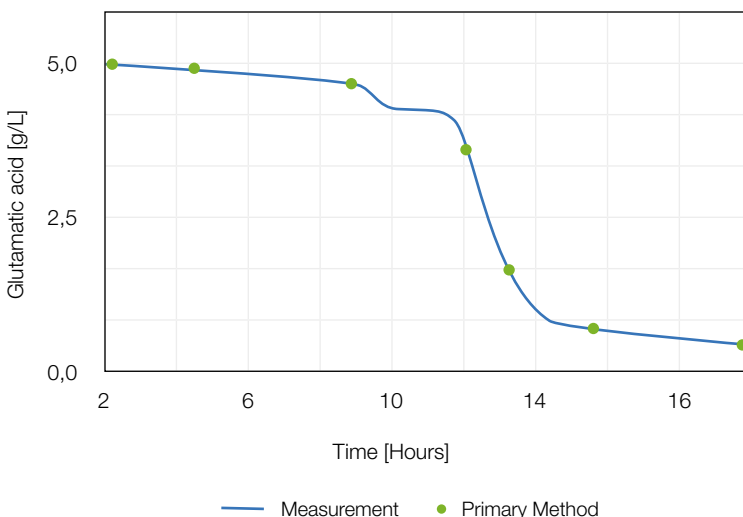

Key parameters by NIR-Online:

- Glucose
- Lactate
- Glutamine, glutamate
- Glutamatic acid
- OD, VCD
- Viability
- Color (L, a, b)

Implementation in a fermentation vessel

Real-time bioprocess monitoring of critical process parameters.

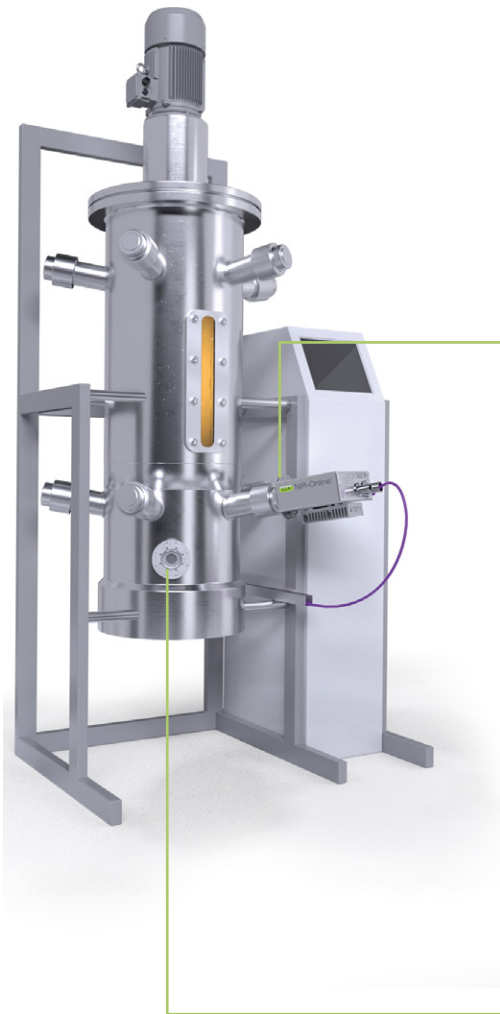

Fiber Free Port installation

An NIR-Online sensor is flanged on the bioreactor by a standard Ingold® port adapter. No further bioreactor modifications and extra work are required.



Weld-In Flange installation

An NIR-Online sensor can be flanged on the side of the fermentation vessel.

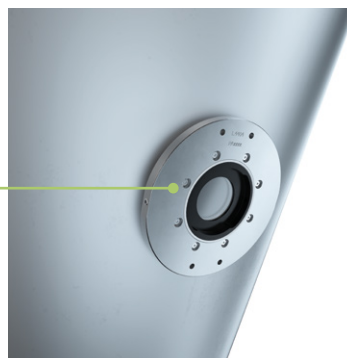

Key facts:

- Ingold® connection: Compatible with most bioreactors
- Weld-In Flange: Large measurement spot and no process and product contact, thus reducing contamination
- Real-time process monitoring and control
- For multiparametric measurement of concentration, e.g., glucose, glutamic acid
- Reducing contamination from frequent sampling

Process optimization in the consumer care industry

Real-time monitoring of moisture during saponification reactions

Soaps are chemical products produced by the saponification reaction of fats and oils (triglycerides). In this reaction, triglycerides are converted into soap (fatty acid) and alcohol (glycerol) by the action of aqueous alkali and heat. Real-time monitoring of key parameters during saponification is crucial for consistent soap quality and better process performance. NIR-Online analyzers enable determination of water content as well as other parameters in real-time, thus allowing immediate in-process adjustment and production closer to targets.

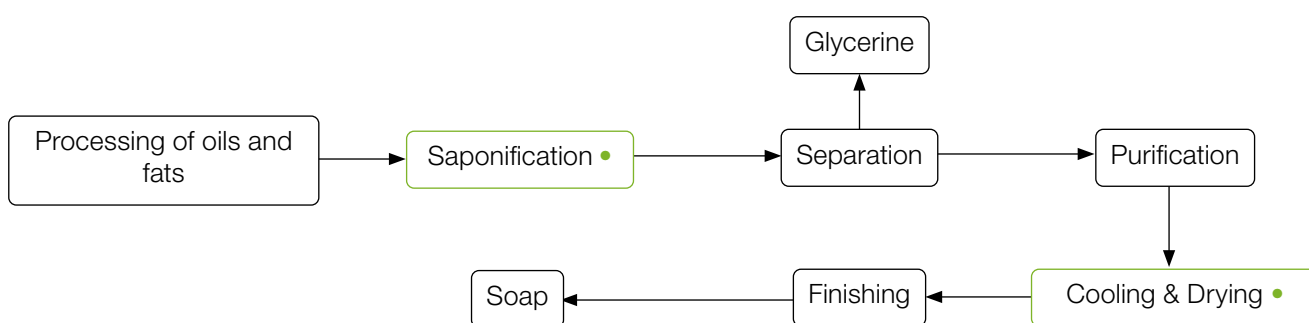

- NIR-Online applications & installation points

Example of moisture content adjustment at the end of the saponification reaction.

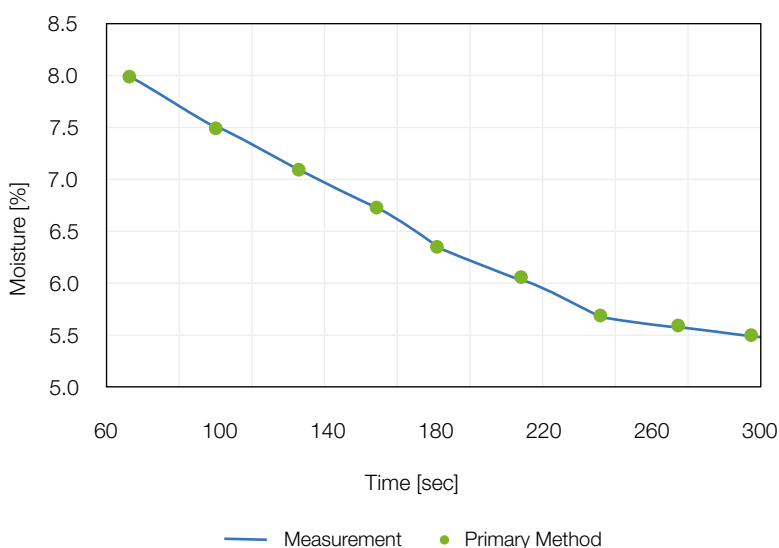

Key parameters by NIR-Online:

- Moisture
- Active detergent (AD)
- Free fatty acids (FFA)
- pH
- Color (L, a, b)

Implementation right on the mixer

An NIR-Online sensor is installed at the lower front side of the mixer for continuous, fast, and accurate measurement of key parameters during the saponification reaction.

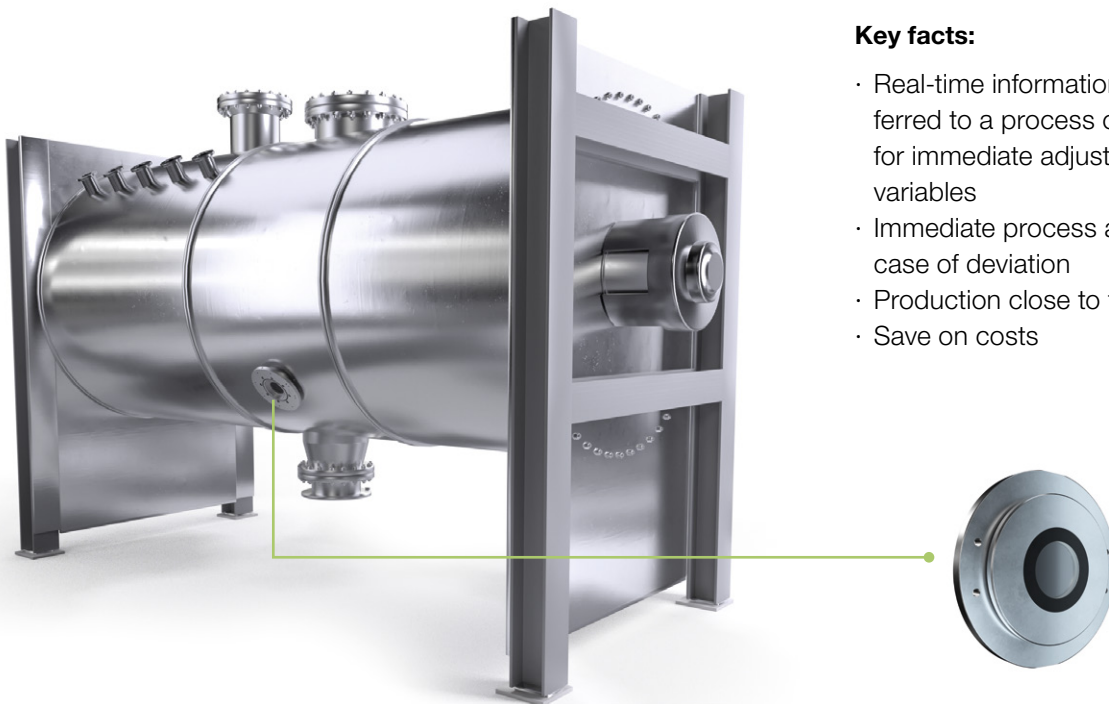

Key facts:

- Real-time information can be transferred to a process control system for immediate adjustment of process variables
- Immediate process adjustment in case of deviation
- Production close to target
- Save on costs

Installation at the cooling rolls

An NIR-Online sensor is installed directly at the cooling rolls within a distance of up to 20 cm between the product and measurement window.

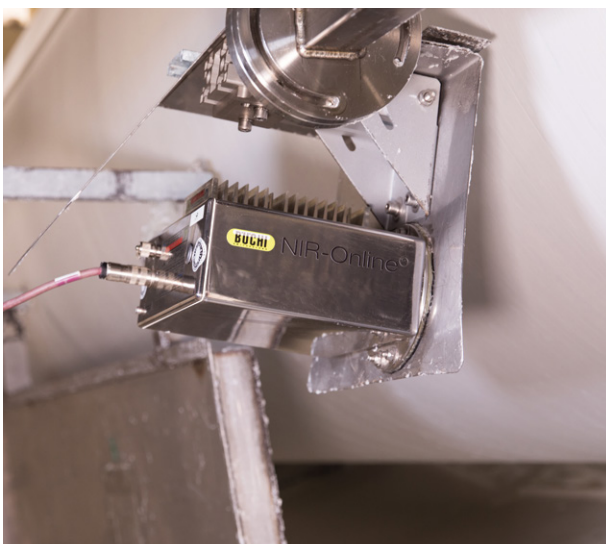

Key facts:

- Easy implementation of the process sensor
- Real-time results and alarms automatically forwarded to the control room
- Feed backward control loop of the saponification step

Process optimization for flooring manufacturing

Ensuring floor performance and safety

Multilayer floor coverings are highly engineered sheet products intended to withstand heavy use in different industrial, commercial, and residential settings. In order to achieve the designed performance, it is of critical importance to monitor the curing process of the calendered sheets in a timely manner. The moisture level is measured after the main dryer for optimal process control. The amount of synthetic polymer, polyurethane, elastomer, PVC, or vinyl brought onto the carrier can be simultaneously measured in order to reach the target values.

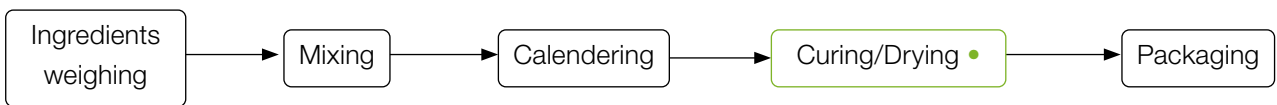

- NIR-Online applications & installation points

Example of residual moisture in flooring sheet

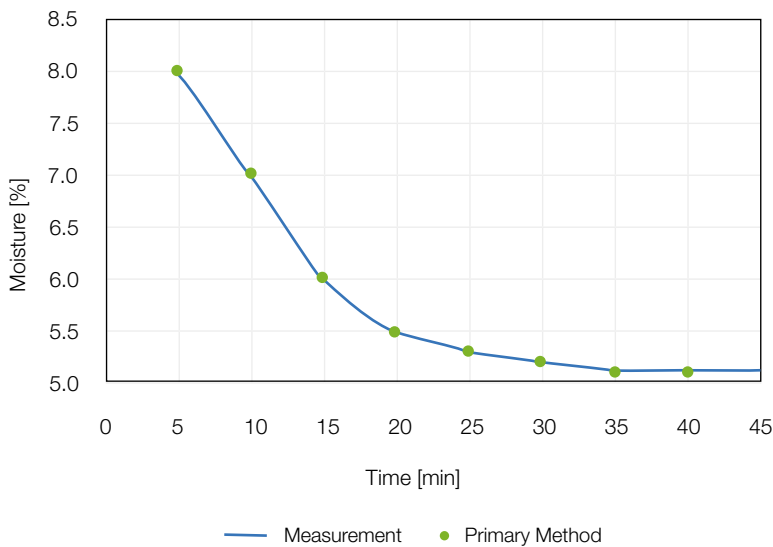

Key parameters by NIR-Online:

- Moisture
- Resin content
- Polymer content

Implementation right to the main line

An NIR-Online Process Analyzer is installed directly above the floor sheet calendering line and measures residual moisture or polymer content.

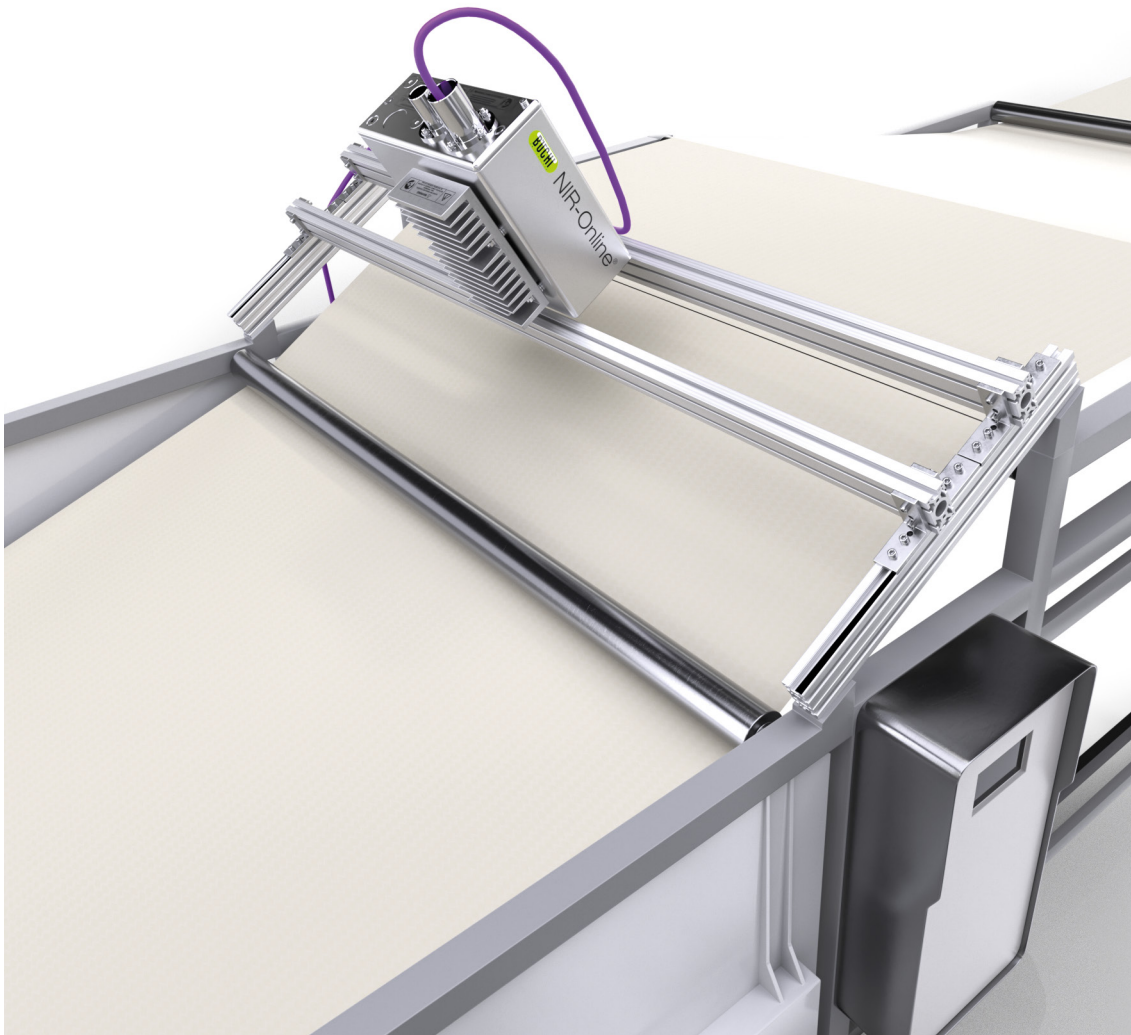
**Key facts:**

- Performs contactless measurements with X-Beam configuration
- Enables a distance of up to 20 cm between the product and measurement window
- Exports the measurement results, alarms, and other relevant information in real-time to the process-control system via a range of available process integration interfaces for an immediate action.

X-One Process Analyzer

Outstanding characteristics



Process analyzer X-One



X-One with battery pack for bluetooth configuration



X-One with X-Cell

■ NIR-Online premium

System Portfolio & Technical Features

Dimensions (W × D × H)	220 × 220 × 135 mm
Weight	7.5 kg
Housing material / Casing	Stainless steel (nickel-coated), aluminum cooler
Wavelength options	900-1700 nm (NIR), 350-900 nm (VIS)
Average measurement time	50 up to 200 spectra/s
High-resolution CCD Camera	optional
Max. operating pressure	30 bar at flange
Ambient temperature	-10 °C – 40 °C
Product / flange temperature	-10 °C – 70 °C (130 °C with water cooler)
ATEX Certification	Dust-Ex and Gas-Ex
Ingress Protection Class	IP66, IP66k, IP68
When to use	<ul style="list-style-type: none"> ·for demanding process applications ·for fast-moving goods such as conveyor belt installations ·for NIR and/or VIS measurements ·for visible detections such as for foreign particles ·in Dust-Ex or Gas-Ex environments

Fast payback in less than one year

Optimize your gross profit margins

Save up to 60'000 € per year

Example of a PET plant where color and Intrinsic Viscosity are tested every 2 hours representing an annual cost of roughly € 35.000 for IV laboratory testing and € 10.000 for color testing. Avoided wasted material saved with real-time monitoring during transition phase was estimated to several tons corresponds to approximately € 15.000 annually. This results in annual savings of € 60.000.

Example of additional savings optimizing Color and IV testing in PET

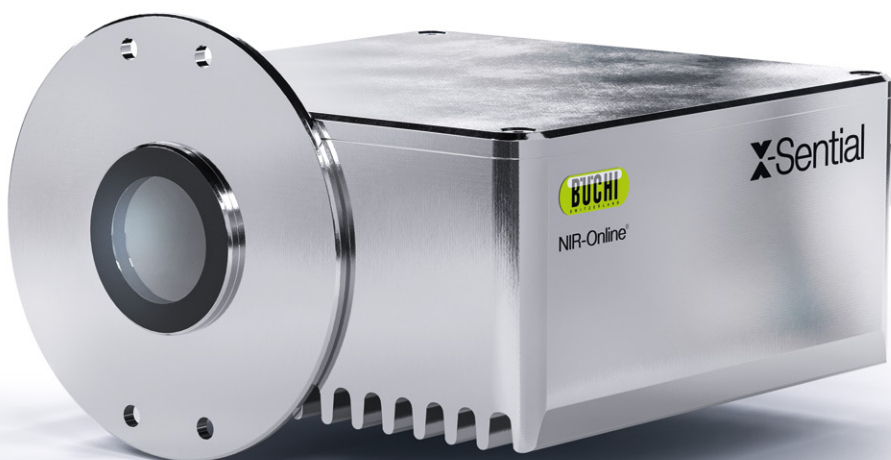
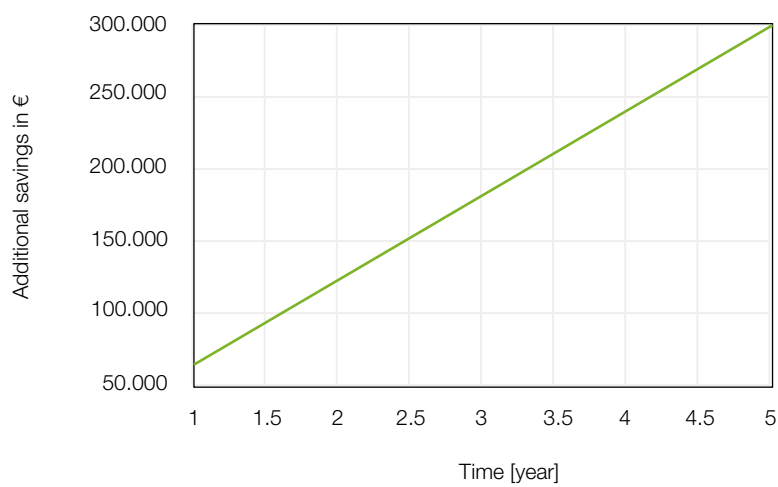

Process analyzer X-Sential™



BUCHI NIR-Online®

fma



AV
VERBODEN TOEGANG
BESCHERMING
SWITZERLAND

After Sales & Service

Competent and fast support

The service and application engineers at BUCHI NIR-Online® have in-depth knowledge of measurement technology and applications. They support you along the project implementation, from the selection and use of mounting accessories, to the right choice of process analyzer configuration, to software operation. Our experts are also available to assist you with any issues that may arise in your day-to-day work with our hardware and software. They will help you optimize your results and get the most out of your high-quality equipment. We support you both remotely and directly in your process environment. Or opt for one of the service packages:

BNO Start Install - The highest efficiency from the very beginning

- Site inspection / hardware and software installation for 1 - 2 sensors
- On-Site introduction
- Calibration development & support / quality check until 3 months after installation
- Operator software training (SX-Suite)
- On-site labor included 1 day

BNO Start Extend +2 / +4

- for 2 / 4 maintenance visits
- warranty extension +2 / +4 years
- On-site labor included 2 x 1 day / 4 x 1 day
- Contract duration limited to 3 years / 5 years after installation

BNO Circle

- Wear and maintenance parts for 1 maintenance visit per year
- Calibration development / quality check 1 time per year for 2 hours
- On-site labor included 1 day
- Total contract duration minimum 3 years, max. 10 years after installation

BUCHI ACADEMY - Increase your know-how, get the edge over your competition

Expert know-how is provided by the application & service experts in our competence centers in Flawil, and our market organizations or remote in our virtual classrooms.

Our scientific support offers pre-sales feasibility studies, tailored solution offers, after sales onsite support, regular basic to advanced courses and on demand customized training.

<https://www.buchi.com/en/knowledge/courses-trainings>

Complementary Products

NIR Spectroscopy

ProxiMate™ is a robust, compact and easy to use at-line NIR instrument. It reduces downtime in production and provides fast quality control of batch samples. The intuitive user interface allows operation by everybody.



ProxiMate™

Benefits:

- Integrated touchscreen, stand-alone
- IP69 certified, At-Line instrument
- AutoCal for calibration development without expert knowledge
- Up- and Down-View possible depending on the individual requirements
- Colour measurements according to CIE norms
- Network possibilities for maximal functionality with BUCHI Flux™ Console

System Portfolio & Technical Features

ProxiMate™ Mode	Sample Types	Measurement Modes	Sample Cups	Optional VIS Detector
Up-View	Powders, granulates, liquids, gels	Reflexion, Transflectance	Glass petri dish, High Performance Sample Cup, Robust Cup	Yes
Down-View	Powders, granulates, very viscous and non-translucent gels	Reflexion	PS petri dish, large sample cup	Yes
Dual-View	Powders, granulates, liquids, gels	Reflexion, Transflectance	All sample cups	Yes

The NIRFlex N-500 is a modular FT-NIR spectrometer that provides reliable analysis results for incoming inspection, quality control, and R&D purposes in various industries. It offers a wide range of measuring cells and accessories as well as highest wavelength precision over the full NIR range.



Benefits:

- Modular design that meets individual requirements
- Compliant with 21 CFR Part 11 as well as US, EU, and Japanese pharmacopoeias regulations
- Highest spectrometer precision
- Identification of raw materials
- Quantification of raw materials, intermediates, and final products

NIRFlex N-500

System Portfolio & Technical Features

NIRFlex N-500 Measurement Cell	Sample Types	Measurement Mode
Solids	Powders, granulates, liquids, gels	Reflexion, Transflectance
Liquids	Liquids	Transmission
Fibre Optics Solids/Liquids	Powders, granulates, liquids, gels	Reflexion (only Fibre Optics Solids), Transflectance
Solids Transmittance	Tablets and capsules	Transmission

Laboratory Evaporation



Rotavapor® R-300

The R-300 meets the highest expectations in convenience and versatility. Modular design allows the extension to a fully integrated system.



Rotavapor® R-100

The entry level Rotavapor® to meet the essential needs in evaporation.



Interface I-300 Pro

The convenient interface with central touch screen control, recording and charting.



Interface I-300

The controlling unit for all process parameters.



VacuumPump V-300 / V-600

The powerful and silent vacuum source.



Recirculating Chiller F-3xx

The efficient way of cooling, optimally suited in combination with Rotavapor® R-300.



Glass Oven B-585 Kugelrohr

For distillation, sublimation, freeze-drying or drying of small samples.



Glass Oven B-585 Drying

The cost efficient way to dry small and medium samples gently under vacuum.

Industrial Evaporation



Rotavapor® R-220 Pro

Perform large distillation processes the most economical way with up to 20 liter flask volume.



Rotavapor® R-250 Pro

Benefit from optimized distillation rate, intuitive operation, exceptional product durability, and highest user safety with up to 50 liter flask volume.



Rotavapor® R-220 EX / 250 EX

Both, R-220 EX and R-250 EX, meet the newest EX regulations and fulfil the highest safety levels.

Parallel Evaporation



Multivapor P-6 / P-12 stand-alone

The Multivapor enables neatless integration of your custom sample tubes and allows parallel evaporation of up to 12 samples.



SyncorePlus

Our SyncorePlus parallel evaporation instrument comes in two configurations; the SyncorePlus Analyst "Pre-Analytical" and the SyncorePlus Polyvap "Throughput".

Spray Drying & Encapsulation



Mini Spray Dryer S-300

With the Mini Spray Dryer S-300, BUCHI solidifies its position as a global market leader for more than 40 years. The laboratory spray dryer combines outstanding product design with unique instrument capabilities to offer a superior user experience.



Nano Spray Dryer B-90 HP

Three patented technologies enable the production of small particles and reduce R&D cost due to small sample volumes and higher yields.



Encapsulator B-395 Pro

Controlled encapsulation of cells, biological and active materials for lab-scale R&D work requiring sterile conditions.



Encapsulator B-390

Facile and flexible operation of the B-390 to produce beads and capsules for numerous actives and materials.

Freeze Drying



Lyovapor™ L-200

Efficient Freeze Drying (-55 °C, 6 kg) with Infinite-Control™ including easy method creation, data logging, chart recording in real time and required interruption at anytime and anywhere.



Lyovapor™ L-300

Infinite-Technology™ offers continuous sublimation with two alternate working and automatically cleaned condensers at -105°C including the Infinite-Control™ for entire process control.

Melting Point



Melting Point M-565

Automated and reliable determination of melting and boiling points with video camera and replay function.



Melting Point M-560

Manual determination of melting and boiling points with intuitive calibration and verification procedures for highly accurate measurements.

Purification

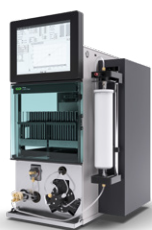

Pure C-810/C-815 Flash

Powerful Flash purification systems, with and without ELS Detection, for maximal flexibility, purity and recovery. With standard remote control.

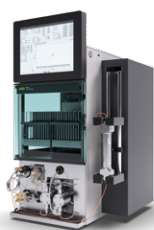

Pure C-830/C-835 Prep

High performance preparative HPLC systems, with and without ELS Detection. One screen programming and auto-recognition of collection racks.

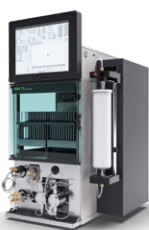

Pure C-850 FlashPrep

Powerful system combining flash and preparative HPLC capabilities. Offers all the benefits of flash and prep systems in one unit.



FlashPure cartridges

A complete range of flash cartridges for optimum performance and loadability.

Core messages to our customers

BUCHI creates added value

“Quality in your hands” is the guiding principle that shapes our philosophy and our actions. It challenges us to provide outstanding services that are precisely tailored to your needs. This means that we must stay in close contact with our customers. That is why we keep in touch and continue to work very hard to understand you and your business even better.

We help you by providing high-quality products, systems, solutions, applications and services that offer you added value. This allows you to focus entirely on your processes and your work.



Competent

We have the technological expertise and decades of experience needed to provide competent support and work with you to continually improve our services.



Reliable

We guarantee the quality and functionality of our equipment and will continue to help you quickly and efficiently whenever something does not operate to your satisfaction.



Safe

By collaborating closely with you, we do everything in our power to make our products, systems, solutions, applications and services as safe as possible for people and the environment.



Cost-effective

We strive to create a high level of economic benefit and maximum added value for you.



Global

As an international family-owned business with own subsidiaries and qualified distributors, we have a presence wherever you are located.



Easy

We support you by providing carefully designed solutions as well as instruments and systems that are easy to operate.



Sustainable

We support environmentally friendly processes and manufacture products that have a long service life. We utilize advanced technologies to leave the smallest environmental footprint possible.

We are represented by more than 100 distribution partners worldwide.
Find your local representative at:

www.buchi.com

Quality in your hands

