

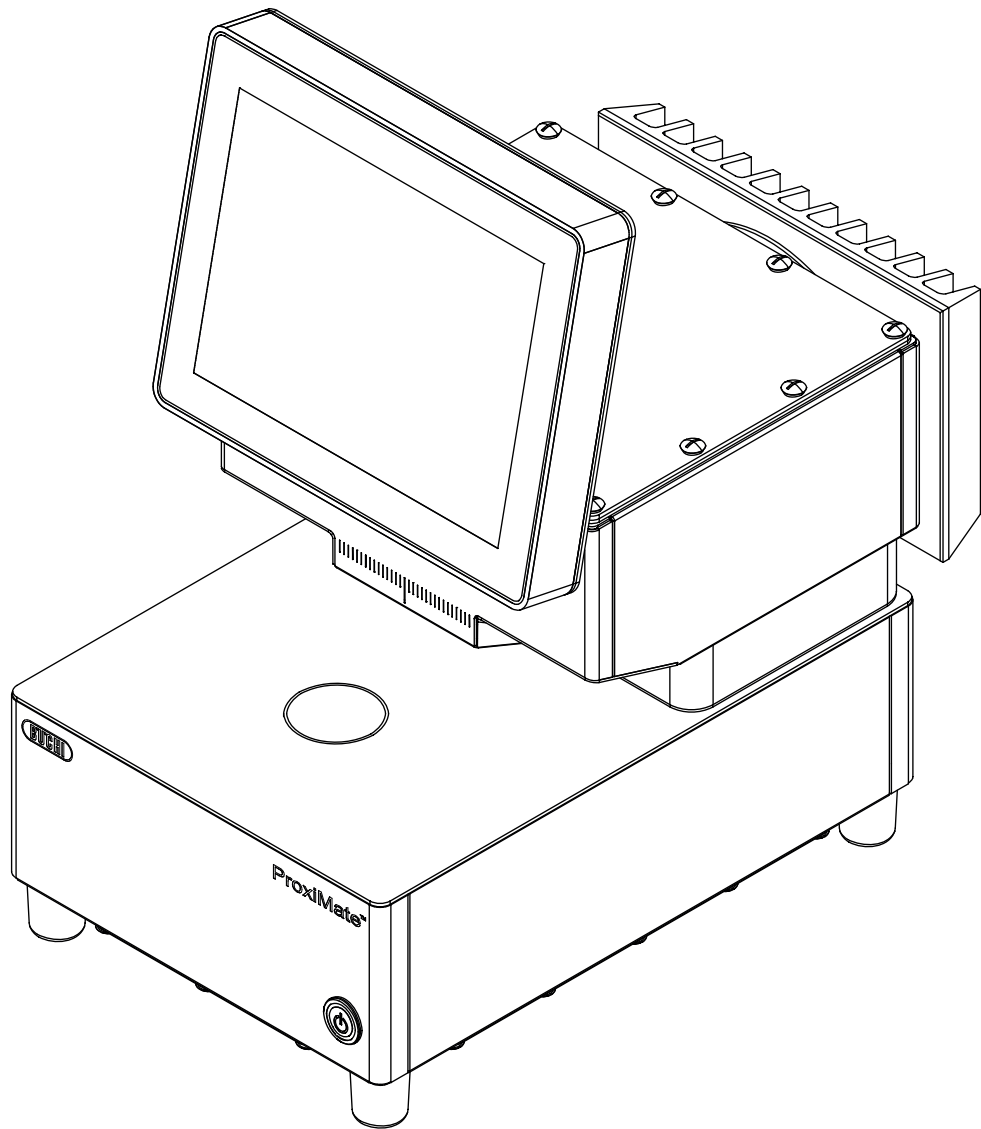

ProxiMate™

Technical data sheet

Depending on specification the BUCHI ProxiMate™ is an NIR or visible light plus NIR spectrometer based on diode array technology. ProxiMate™ is designed especially to work in the food and feed production environments and features a robust housing design sealed to IP69 ingress protection standard. The stainless steel case is designed to prevent corrosion when acidic, basic or chlorine detergents are applied.



Order code

Choose the configuration according to your needs:

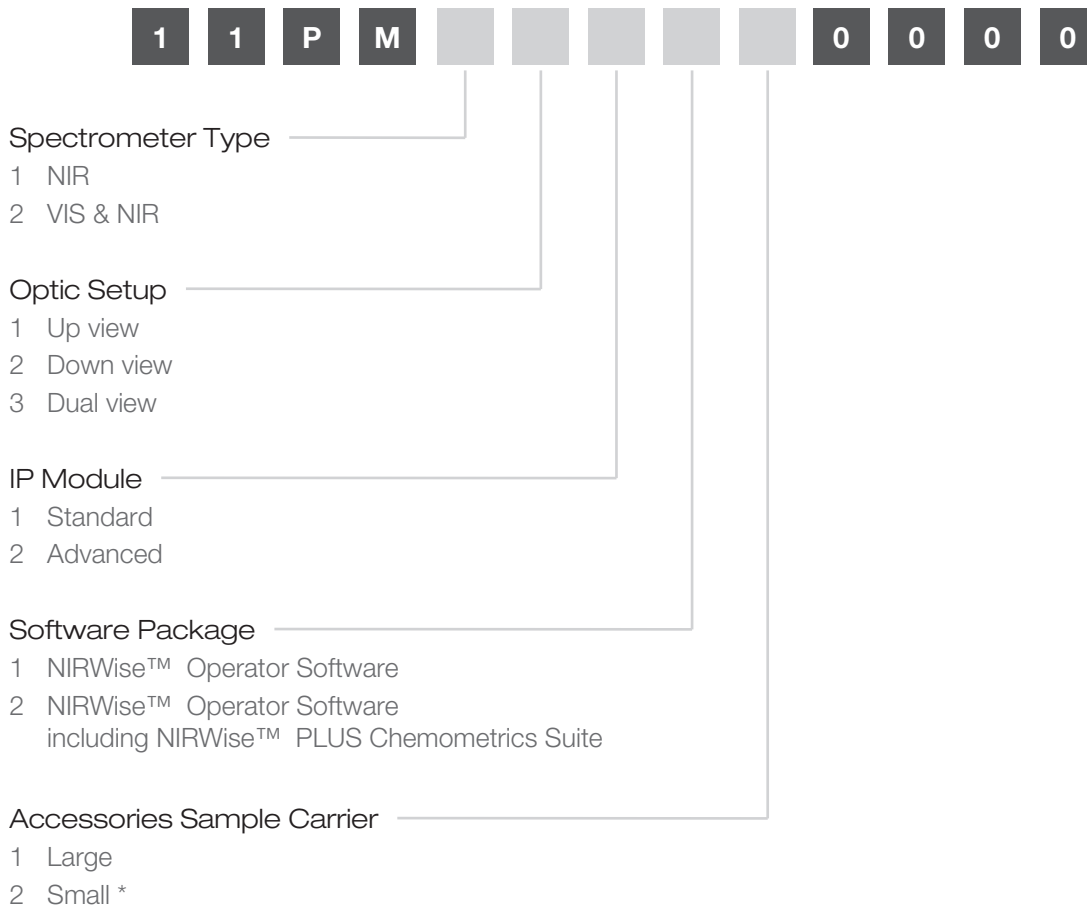

* Available with down view configuration only

Scope of delivery

All configurations are supplied ready to use.

ProxiMate™	1
including white reference standard, spacers and positioning plate	
Operation Manual	1
Guide for electrical installation	1
Quick Guide	1

Technical data

ProxiMate™

Specification	ProxiMate™
Dimensions (W x D x H)	260 x 435 x 500 mm
Weight	23 kg
Power consumption	60 W
Frequency	50 / 60 Hz
Connection voltage	100 - 240 VAC ± 10 %
Max. power for all USB-Ports	5 W
IP Code	IP69
Overvoltage category	II
Pollution degree	2
Appliance classes	I
Detector NIR	Thermoelectrically cooled InGaAs
Detector VIS	Si
Wavelength range NIR	900 - 1700 nm
Resolution NIR	7.0 nm
NIR Data Resolution	3.1 nm
Wavelength range VIS	400 - 900 nm
Resolution VIS	Better than 15 nm
VIS Data Resolution	2 nm
Up view illumination spot size	8 mm
Down view illumination spot size	30 mm
Approval	CE / CSA
Lamp type	Tungsten-halogen
Average life (lamp)	9000 h
Display	10.4 in

Ambient conditions

For indoor use only.

Max. altitude above sea level	2000 m
Ambient temperature	5 - 40 °C (25 °C)
Maximum relative humidity	80% for temperatures up to 31 °C
Storage temperature	max. 45 °C

Description of function

ProxiMate™ is a NIR spectrometer that can be used to determine the concentration of different parameters in food and feed samples in a nondestructive way.

ProxiMate™ is supplied in different versions. Dependent on the version specified ProxiMate™ is either an NIR or combined NIR and visible spectrometer.

The instrument generates a beam of NIR (and visible) light which is focused onto the sample under investigation. Light reflected from the sample is collected and spatially separated by a diffraction element. The diffracted light is directed onto a diode array detector. Signals from the detector are processed and a reflectance spectrum is constructed. This spectrum undergoes further processing to calculate the constituents required.

Data processing

The NIR light interacts with the sample material in different ways, leaving a characteristic fingerprint on the spectrum. Spectra from both liquids and solids can be measured with ProxiMate™. The spectra of solid samples are collected directly, liquid samples require the use of a transmittance adapter.

Sample presentation options

The choice of sample presentation of ProxiMate™ is optimised for the type of sample under analysis and for the working environment where the instrument is used.

ProxiMate™ can be configured with a choice of sample presentation options: up view and down view configurations.



NOTE

You can capitalise on the advantages of the up view and down view options in a single instrument.

Up view option

The up view option directs and collects light from the underside of the sample. The NIR light passes through the base of a glass petri dish before interacting with the sample under evaluation. Up view measurement has the advantage that a more consistent surface is presented to the ProxiMate™ ensuring accurate measurement output. Glass petri dishes are recommended to enable best performance. Additionally, when used in conjunction with a transmittance adapter, it is also possible to measure liquids using the up view option.



NOTE

Choose the up view option for the most consistent measurement performance or for measurements of liquids.

Down view option

With down view option light is focussed onto and collected from the top surface of the sample. In areas where glass is prohibited (such as some food production areas), the down view mode offers the advantage that NIR light does not interact with the sample container. As plastics have their own NIR spectra, changes in type of dish can influence the measurement output leading to perceived measurement shifts. Use of the down view mode prevents this from occurring. Additionally ProxiMate™ down view also allows the use of large volume sample dishes. These are particularly useful with samples that are inhomogeneous, as the measurement is averaged over a much larger sample area.







NOTE

Choose the down view option for areas where glass is prohibited or where larger sample volumes are required.

Spare parts and accessories

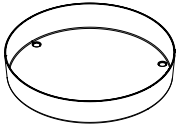
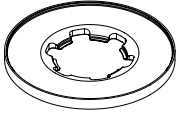
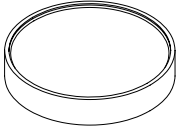
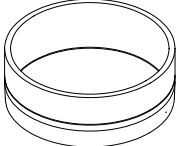
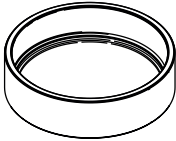
Accessories

	Order no.	Image
External White Reference	11067547	
White reference spacer for down view	11067378	
White reference spacer for up view	11067377	
White reference locating plate	11067391	
PET Large Sample Cup	11067692	
FDA food approved large sample cup	11068015	
Glass petri dishes 10 pcs. (up view) Not suitable for use with Transflectance Cover	11072073	
Plastic petri dishes 240 pcs. (down view)	11066381	

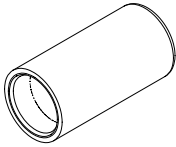
	Order no.	Image
Stainless steel petri-dish For down view measurements only	11074314	
Carrier for large deep sample cup plus petri dish	11067691	
Carrier for small sample cup (down view)	11065472	
High Performance Sample Cup	11067399	
Robust cup	11055058	
Transflectance cover 0.3 mm Not suitable for use with robust cup	041636	
Transflectance cover 2.0 mm For measurement of crude palm oil. Not suitable for use with robust cup.	11067919	
Transflectance cover for robust cup	11055998	
Protection cover USB-WiFi stick	11066582	

	Order no.	Image
Light shield (down view)	11067281	
Performance test standards kit (7 pcs.)	11067545	
Recertification of performance test standards kit	11070905	
NIRWise PLUS Chemometrics suite	11068025	
Set Network cable RJ45 5m	11068780	

Spare parts

	Order no.	Image
Spare lamp	11065441	
Desiccant cartridge Shelf life in original packaging is 12 months	11065467	
Replacement Window HPSC	046246	

Maintenance kits

	Order no.
Kit Customer ProxiMate Frequently used wear and spare parts for self-servicing your device, conveniently gathered in one kit	11062670