

Technical data sheet

Rotavapor® R-220 EX

The Rotavapor® R-220 EX is the EX rated version of the Rotavapor® R-220 Pro and fulfills the high requirements of the ATEX regulations. It is designed for easy and safe operation combined with high performance.



Scope of delivery

All configurations are supplied ready to use.

Components	R-220 EX
Vacuum controller EX	1
Vacuum valve EX	1
Glass configuration according to order configuration	1
Evaporating flask according to order configuration	1
All needed tubing (vacuum and cooling)	1
Seal removing tool	1

Order code

Choose the configuration according to your needs:

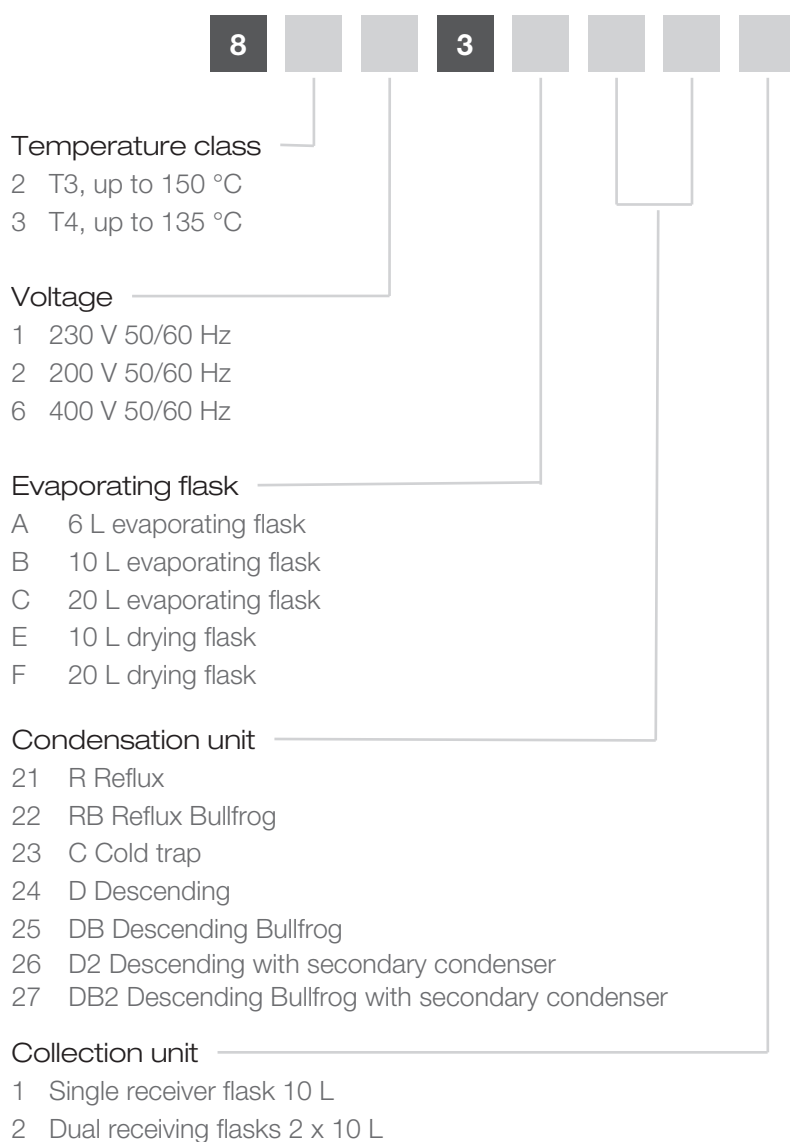

Glassware

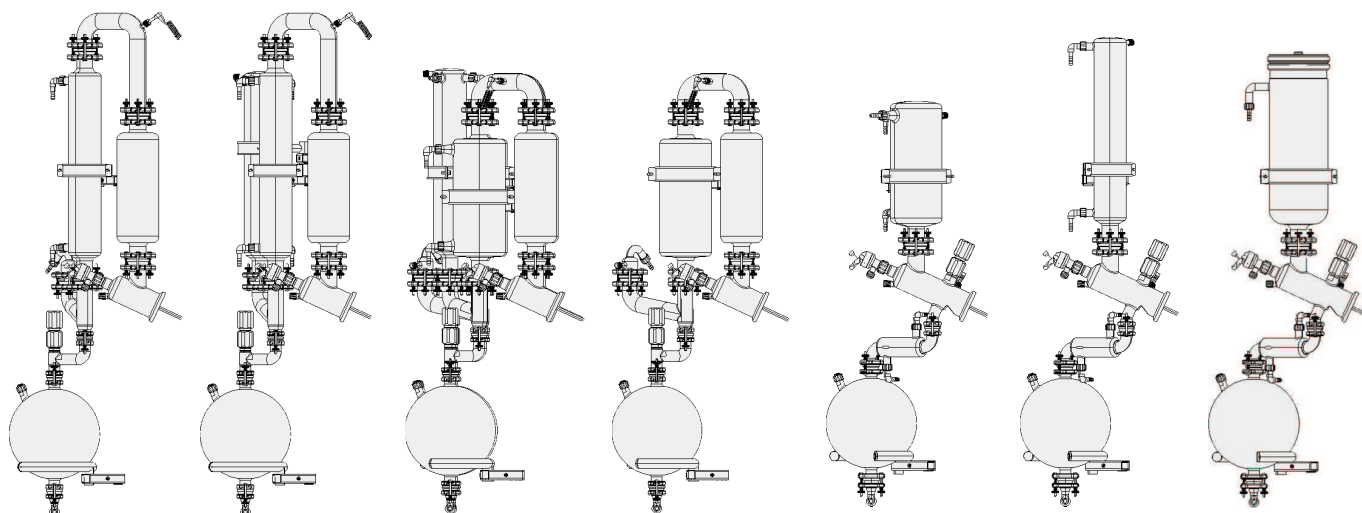

D	D2	DB2	DB	RB	R	C
Low boiling points and/or foaming products				High boiling points		Very low boiling point
Minimum emissions				Reflux reactions		
Reduced height						
175 cm	175 cm	150 cm	150 cm	143 cm	163 cm	158 cm

	Dimensions (W x H x D)			Weight		
R-220 EX without glass	950	x	880	x	660	mm 75 kg
Assembly R	1200	x	1630	x		mm 7.7 kg
Assembly RB	1200	x	1430	x		mm 9.9 kg
Assembly C	1200	x	1580	x		mm 13 kg
Assembly D	1200	x	1750	x		mm 11 kg
Assembly DB	1200	x	1500	x		mm 13 kg
Assembly D2	1200	x	1750	x		mm 15 kg
Assembly DB2	1200	x	1500	x		mm 17 kg
One receiving flask	1200	x		x	660	mm 5 kg
Two receiving flasks	1200	x		x	750	mm 6 kg

For the overall weight, summarize the related components.

Technical data

Electrical

Voltage	200 V ± 10 % 230 V ± 10 % 400 V ± 10 %
Frequency	50 – 60 Hz
Power consumption	4200 W

Standards

EX label	Ex II 2G Ex db eb h ib [ibGb] IIC T3 or T4 Gb
CE marking	Yes

Safety

Safety coated glassware	No, due to the risk of electrostatic charges
Over temperature protection of the bath	Separate monitoring circuit with manual reset
Rotation	Soft start
At any Error	Bath lowering, heater off, rotation off Indication of error

Display

Bath temperature	1 °C steps
Vapor temperature	1 °C steps
Set rotation speed	Yes, but no display
Set bath temperature	1 °C steps
Actual vacuum	1 mbar steps
Set vacuum	1 mbar steps

Cooling

Consumption	120 – 200 liter/hour (adjustable via integrated needle valve)
Restriction	max. 2.7 bar abs. without pulsation

Heating (bath)

Medium	Water or oil
Temperature range	Ambient to 115 °C (T4) or 150 °C (T3)
Heating capacity	3600 W (3 W/cm ²)
Accuracy	+/- 2 °C

Rotation

Motor	Pneumatic, 6 bar, oil-free
Controlling	Continuous with precision regulator valve

Speed	0 - 100 rpm
Accuracy	no display

Materials

Housing	Stainless steel 1.4301 (AISI 304)
Gear head	Aluminum cast (3.2373)
Painting	Powder coated with Epoxy (EPX)
Bath pan	Stainless steel 1.4404 (AISI 316L)
Heating element	Stainless steel 1.4404 (AISI 316L)
Glass	Borosilicate 3.3
In contact with product	FDA approved materials

Sensors

Vapor temperature	PT-1000, 2 wire
Bath temperature	PT-1000, 2 wire
Vacuum	Piezoresistive measuring cell; stainless steel 1.4435 (AISI 316 L)

Accessories

System

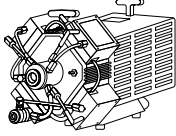
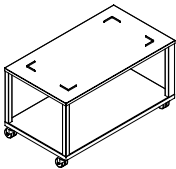

	Order no.	Image
Vacuum pump MD4C EX PTFE membrane pump with a capacity of 3.7m ³ /h and a final vacuum of 3mbar. 230 V / 50 Hz.	040197	
Trolley Stainless steel trolley with extra space.	041257	

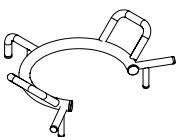
Safety

	Order no.	Image
Manual flask handler for 20 L flask For easy mounting and removal of the flasks along with safe transport.	041400	
10 L adapter for flask handler	11079769	

	Order no.	Image
Bath shield Shield to protect the operator from splashes. Made in stainless steel.	046431	

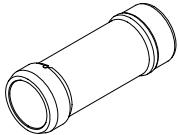
Various

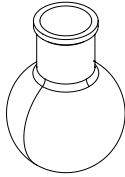
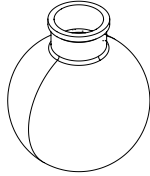
	Order no.	Image
Vapor duct with integrated sinter plate The integrated sinter plate P3 protects the condenser assembly against powder and dust during the drying process.	041100	
Flange adapter for flasks , SJ29.2/32 To use a 1, 2 or 3 L evaporating flask with SJ29.2/32	11058738	
Evaporation flask 10 L, amber 10 L flask with UV-protection, flange 150 mm	11069604	
Evaporation flask 20 L, amber 20 L flask with UV-protection, flange 150 mm	11069605	
Stopper, PE, 120 mm To close the evaporating flask	11057349	
IQ / OQ	040786	

Spare parts

	Order no.	Image
Evaporating flask 6 L D150 For a sample volume of max. 4 L. Flange size 150 mm.	027470	
Evaporating flask 10 L D150 For a sample volume of max. 6 L. Flange size 150 mm.	027469	

	Order no.	Image
Evaporating flask 20 L D150 For a sample volume of max. 10 L. Flange size 150 mm.	027468	
Drying flask 10 L D150 Special shaped to dry up to 5 L product. Flange size 150 mm.	028592	
Drying flask 20 L D150 Special shaped to dry up to 9 L product. Flange size 150 mm.	028593	
Vapor duct	041084	
Vacuum seal, PTFE base	041095	
Evaporating flask seal, complete	041121	
FEP coated silicon gasket for DN25 (set of 5)	11056381	
FEP coated silicone gasket for DN40 (set of 5)	11056382	

Performance

The following chart shows the maximum distillation rate.

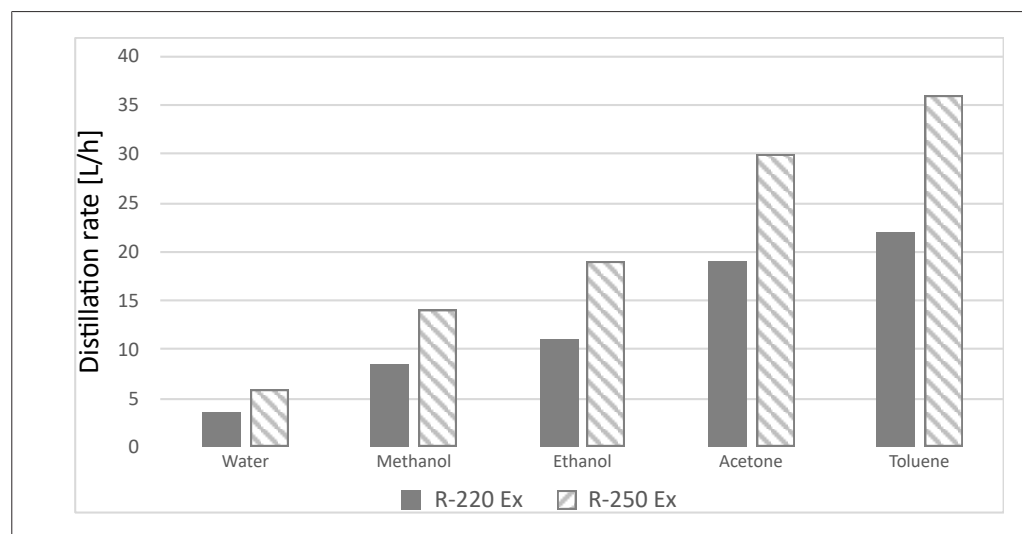

The maximum achievable distillation rate is not just related to the heating capacity, but also on rotation speed, flask size and temperature difference between bath and cooling.

To get a high distillation rate:

- set a high rotation speed
- choose a large evaporating flask (20 L)
- set a high temperature difference between bath and cooling



11594545H en Rotavapor® R-220 EX 04.2024
Technical data are subject to change without notice
Quality Systems ISO 9001

We are represented by more than 100 distribution partners worldwide.
Find your local representative at:

www.buchi.com

Quality in your hands
