

### Technical data sheet

## KjelDigester K-446 / K-449

The KjelDigester offers fast and safe digestion of up to 20 samples simultaneously. The fully automated model K-449 offers a convenient automatic lift for raising and lowering the sample tube rack and a programming mode so that all digestion methods can be saved. The manual K-446 is an entry level block digester with effortless manual control and manual rack handling. The sample tube rack of both digesters can be placed directly into the KjelSampler K-376 and K-377 for fully automated, high throughput nitrogen and protein determination according to Kjeldahl.



## Scope of delivery

The Kjeldigester models are delivered ready to use with the standard package comprising of:

Components	Qty
Sample tubes 300 mL	20
Rack 20 position	1
Suction module *	1
Hose to Scrubber 1.5 m	1
Hose connector S19 (ball joint)	1
Clamp for hose connector S19	1
Drip tray	1
Drip tray holder	1

\* standard or with condensate trap

## Order code

Choose the configuration according to your needs:

1 1 5 4 4 [ ] [ ] 0 0 0

Kjeldigester model

- 6 K-446 (manual)
- 9 K-449 (fully automated)

Suction module

- 1 Suction module standard
- 2 Suction module with condensate trap

## Technical data

### KjelDigester

	K-446	K-449
Dimensions (W x D x H)	472 mm x 524 mm x 764 mm	472 mm x 558 mm x 764 mm
Weight	18.5 kg	25.8 kg
Weight	30.3 kg	37.3 kg
Operating voltage	220–240 V $\pm$ 10 %	220–240 V $\pm$ 10 %
Frequency	50 / 60 Hz	50 / 60 Hz
Power consumption	max. 2,300 W	max. 2,300 W
Display	LCD (2 lines)	LCD (2 lines)
Temperature range	30–450 °C	30–450 °C
Resolution temperature display	$\pm$ 1 °C	$\pm$ 1 °C
Average temperature stability	$\pm$ 1 °C	$\pm$ 1 °C
Temperature accuracy absolute	$\pm$ 7 °C at 420 °C	$\pm$ 7 °C at 420 °C
Certificate	UL / CSA, CE	UL / CSA, CE

### Dimensions

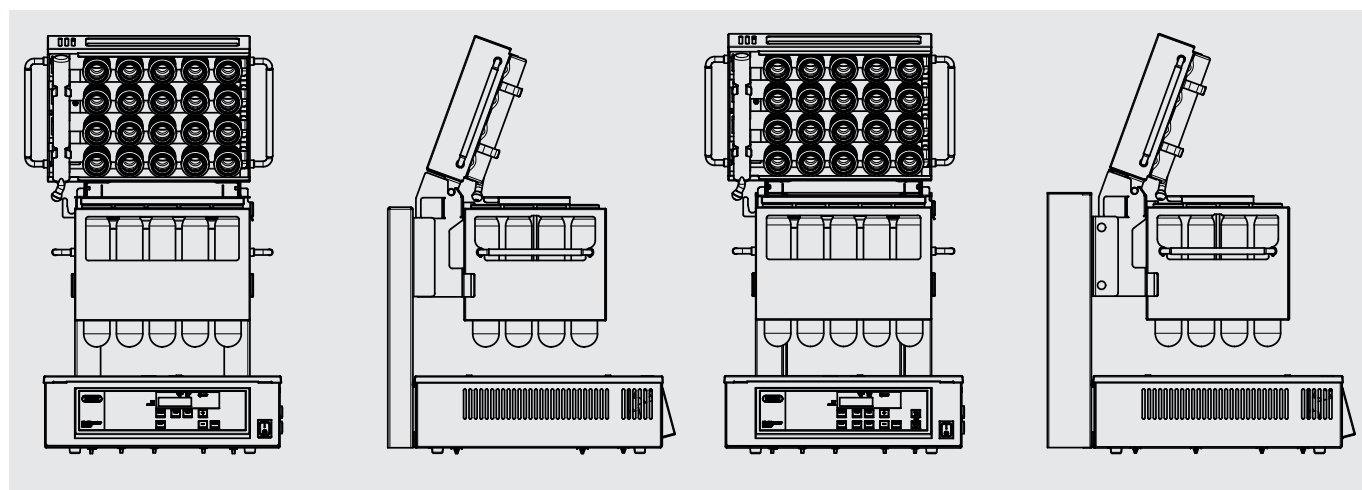

KjelDigester K-446

Front view

Side view

KjelDigester K-449

Front view

Side view

### Ambient conditions







For indoor use only.

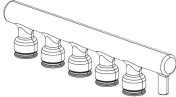

Specification	Value
Max. altitude above sea level	2,000 m
Ambient and storage temperature	5–40 °C
Max. relative humidity	80% for temperatures up to 31 °C decreasing linearly to 50% relative humidity at 40 °C

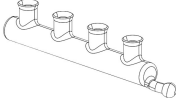
## Spare parts and accessories

### Accessories

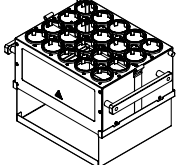
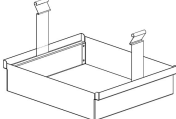
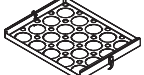
#### General accessories

Specification	Order no.	Image
Suction tube standard Suitable for most applications	11058651	
Suction tube with condensate trap For aqueous samples, prevents backflow of condensate into the sample tube	11058827	
Fume collection tube with ball joint Collects the digestion fumes from the four suction modules	11058825	
Sample tubes 300 mL, 4 pcs. For sample volumes up to 200 mL or 5 g in weight	037377	
Sample tubes 300 mL 20 pcs.	11059690	
Glass caps, 4 pcs. For occupying empty sample positions, to close the suction circuit	040049	
Rack with 20 positions for 300 mL tubes	11059831	
Stand for rack Protects the sample tubes from smashing, as well as other damage.	11058659	
Retaining plate Holds the tubes firmly in the rack when it is placed into the dishwasher for cleaning.	038559	

Specification	Order no.	Image
Air supply for internal fan Supplies clean air to the display, as well as the built-in fan	040079	
Brush for cleaning troughs in the block Is used in conjunction with an electric drill to remove heavy soil- ing's, it exactly matches the throughs in the block	043929	

## Application related accessories

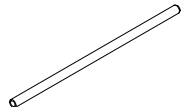
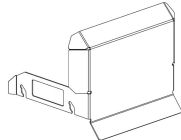
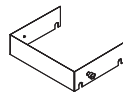
Specification	Order no.	Image
Digestion rods To prevent boiling delays, 10 pcs.	043087	
User protection shield (for H <sub>2</sub> O <sub>2</sub> and TKN applications) Protects the user from any possible splashes, which may occur from H <sub>2</sub> O <sub>2</sub> usage or boiling delays 10 pcs	11057889	
Heat shield for rack Provides heat insulation for sample tubes during digestion	040052	
Weighing boats Nitrogen-free weighing paper 58 x 10 x 10 mm, 100 pcs.	11060522	

## Documentation

	Order no.
Kjeldahl Guide (EN) Comprehensive guide covering all aspects of the theoretical and practical know-how	11055033
Kjeldahl Practice Guide (EN) Provides theoretical background information, useful hints and calculation tables for daily rou- tine work	11592548
Kjeldahl Practice Guide (DE)	11592547
Kjeldahl Practice Guide (CN)	11592549
IQ/OQ set (EN) Complete set for Installation and Operational Qualification of the instrument	11059762
Repeating OQ (EN)	11059763

## Fume removal

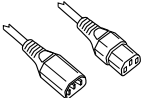
Specification	Order no.	Image
Condensate bottle (secondary)	025100	
Connection cable to digester The Scrubber is controlled by the digester by the cable connection (already incl. at Scrubber ECO models)	030973	
Scrubber K-415 (TripleScrubECO) Ideal Scrubber model for Kjeldahl digestions at maximum automation	114152331	

## Kjeldahl tablets

	Order no.
Kjeldahl Tablets Titanium For efficient digestions, 1000 tablets (3.5 g K <sub>2</sub> SO <sub>4</sub> / 0.105 g CuSO <sub>4</sub> * 5 H <sub>2</sub> O / 0.105 g TiO <sub>2</sub> )	11072627
Kjeldahl Tablets Titanium Micro For small sample sizes, 1000 tablets (1.5 g K <sub>2</sub> SO <sub>4</sub> / 0.045 g CuSO <sub>4</sub> * 5 H <sub>2</sub> O / 0.045 g TiO <sub>2</sub> )	11072628
Kjeldahl Tablets Missouri For efficient digestions without Titanium, 1000 tablets (4.98 g K <sub>2</sub> SO <sub>4</sub> / 0.02 g CuSO <sub>4</sub> * 5 H <sub>2</sub> O)	11072629
Kjeldahl Tablets ECO For eco-friendly digestions with minimum amount of copper, 1000 tablets (3.998 g K <sub>2</sub> SO <sub>4</sub> / 0.002 CuSO <sub>4</sub> * 5 H <sub>2</sub> O)	11072630
Kjeldahl Tablets Antifoam For foaming samples in digestions to avoid cross contamination due to foaming, 1000 tablets (0.97 g Na <sub>2</sub> SO <sub>4</sub> / 0.03 g Silicone)	11072631
Kjeldahl Tablets Copper Micro For small sample sizes without Titanium, 1000 tablets (1.5 g K <sub>2</sub> SO <sub>4</sub> / 0.15 g CuSO <sub>4</sub> * 5 H <sub>2</sub> O)	11072632

## Functional principle

The KjelDigester is used to convert organic bound nitrogen (e.g. in proteins) in a sample into ammonium sulfate. During the digestion process, acid fumes and reaction gases may emerge and are handled by the Scrubber K-415. The K-415 is connected to digester system for neutralizing acid fumes and adsorbing unpleasant odors.

- The aluminum block (1) generates high temperatures in the samples (2)
- The sample is digested in constantly boiling sulfuric acid
- Hot acid fumes rise into the condensation zone (3), and condense and rinse back down to the sample creating a constant reflux
- Residual fumes (4) which escape the condensation zone are highly corrosive and must be withdrawn and efficiently neutralized (e.g. with the Scrubber K-415)

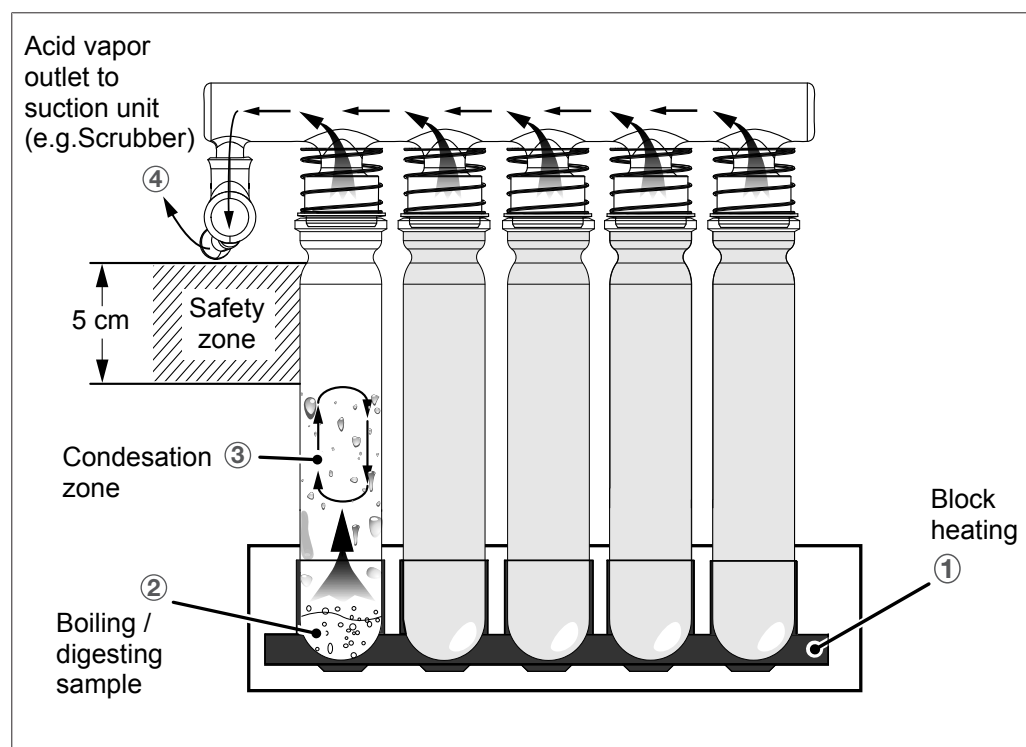



11594611C en KjelDigester K-446 / K-449 11.2024  
Technical data are subject to change without notice  
Quality Systems ISO 9001

---

We are represented by more than 100 distribution partners worldwide.  
Find your local representative at:

[www.buchi.com](http://www.buchi.com)

Quality in your hands

---