

**Technical data sheet**

## **Rotavapor® R-300**

The Rotavapor® R-300 meets the highest expectations in convenience and versatility for rotary evaporation. Its modular design allows for easy extension of the R-300 to a fully integrated system where a central interface regulates each component.



## Overview of Rotavapor® R-300 stand-alone and systems configurations

	Stand-alone configuration	System configuration
Rotavapor® R-300 / R-300 Hand Lift**	1	1
Heating Bath B-301 / B-305**	*	1
Interface I-300 / I-300 Pro (incl. VacuBox)**	*	1
Vacuum Pump V-300	-	1
Recirculating Chiller F-305 / F-308**	-	*

\* Optional, according to order code

\*\* According to order code

### Rotavapor® R-300

The Rotavapor® R-300 represents high reliability and convenience in laboratory rotary evaporation applications. The Rotavapor® R-300 is available with either an electronic or manual lift, and can optionally include the Heating Bath B-301 or B-305 and, a glass assembly of your choice and the Interface I-300 or I-300 Pro.

All accessories and connections are included for out of the box usage.

## Order Code

Choose the configuration according to your needs:



### Electric lift

Included

### Heating Bath

0 Without

5 B-305: 20 – 220 °C, max. flask size: 5 L

### Standard Joint

0 Without (w/o evaporating flask, w/o vapor duct)

1 SJ 29/32 (incl. evaporating flask, vapor duct)

2 SJ 24/40 (incl. evaporating flask, vapor duct)

### Glass Assembly

N 0 Without (w/o receiving flask) <sup>1</sup>

V 1 Vertical (incl. receiving flask)<sup>2</sup>

C 1 Cold trap (incl. receiving flask)<sup>2</sup>

S 1 Vertical reflux (incl. receiving flask)<sup>2</sup>

### Interface

0 Without

1 Without, with Woulff bottle

2 I-300, with Woulff bottle (incl. VacuBox)

3 I-300 Pro, with Woulff bottle (incl. VacuBox)

4 I-300, with valve unit (incl. VacuBox)

5 I-300 Pro, with valve unit (incl. VacuBox)

### Voltage

1 220 – 240 V

2 100 – 120 V

<sup>1</sup> If glass assembly A, E, CR, HP, BF or BY is required, for Glass Assembly select “N”, for Standard Joint select either “1” or “2”. Glass assembly E, CR, HP, BF or BY need to be ordered separately.

<sup>2</sup> Safety coating applies to the condenser and receiving flask. Safety coating is sensitive to higher vapor temperatures.

## Scope of delivery of Rotavapor® R-300 stand-alone configuration

All configurations are supplied ready to use.



### NOTE

The scope of delivery depends of the configuration of the purchase order.

Accessories are delivered as per the purchase order, order confirmation, and delivery note.

Component	Specifications supplied
Rotavapor® R-300 / R-300 Hand Lift**	1
Heating Bath B-301 / B-305**	*
Glass assembly**	*
Vapor duct (with Combi-Clip)	**
Vacuum seal VS26	1
Evaporating flask (1 liter)	**
Receiving flask (1 liter)	**
Flyer "List of solvents"	1
Power cable (1 for heating bath, 1 for Rotavapor®)	**
Set of required cooling tubings	**
Interface I-300 / I-300 Pro**	*
VacuBox	*
Communications cable. BUCHI COM 6 p	*

\* Optional, according to order code

\*\* According to order code

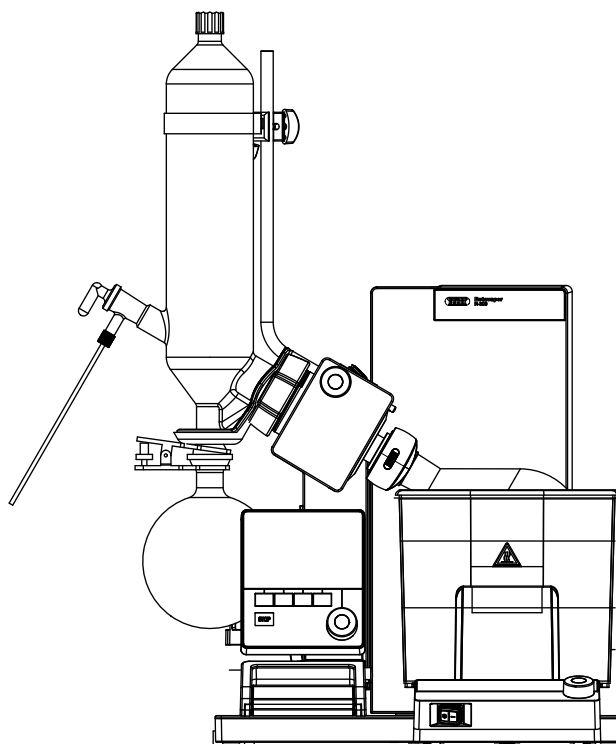

## Rotavapor® R-300 system configuration

The rotary evaporator R-300 system meets the highest expectations in convenience and versatility. It is bundled with the Vacuum Pump V-300, controlled by the Interface I-300 / I-300 Pro and can include the Recirculating Chiller F-305 / F-308. The interface is the central control unit for all process parameters. Rotation speed, heating-, cooling-, vapor-temperature and pressure are perfectly synchronized to optimize the distillation process while increasing efficiency and convenience. All the Rotavapor® R-300 system configurations are P+G coated. All accessories and connections are included for out of the box usage.

Choose the configuration according to your needs:

<b>1</b>	<b>1</b>	<b>S</b>	<b>R</b>	<b>3</b>	<b>0</b>	<b>0</b>	<b>2</b>						
Electric lift													
Included													
Vacuum Pump V-300													
Included													
Heating Bath B-305													
Included: 20 – 220°C, max. flask size 5 L													
Secondary condenser													
5 Without													
6 Included													
(V or C depending on Glass assembly)													
Standard Joint													
1 SJ 29/32 (incl. evaporating flask, vapor duct)													
2 SJ 24/40 (incl. evaporating flask, vapor duct)													
Glass Assembly													
V Vertical													
C Cold trap (condenser and receiving flask are also LT coated) <sup>1</sup>													
N Without (w/o receiving flask, secondary condenser)													
Interface													
S I-300, with Woulff bottle (incl. VacuBox)													
P I-300 Pro, with Woulff bottle (incl. VacuBox)													
Recirculating Chiller													
0 Without													
1 F-305: cooling capacity 550 W at 15 °C (-10 – 25 °C) <sup>2</sup>													
2 F-308: cooling capacity 900 W at 15 °C (-10 – 25 °C) <sup>2</sup>													
Voltage													
1 220 – 240 V													
2 100 – 120 V													

<sup>1</sup> When ordering the glass assembly C, a recirculating chiller is not needed

<sup>2</sup> Cannot be purchased with a C condenser

## Scope of delivery of Rotavapor® R-300 system configuration

All configurations are supplied ready to use.



### NOTE

The scope of delivery depends of the configuration of the purchase order.

Accessories are delivered as per the purchase order, order confirmation, and delivery note.

Component	Specifications supplied
Rotavapor® R-300 / R-300 Hand Lift**	1
Heating Bath B-301 / B-305**	1
Glass assembly	1
Vapor duct (with Combi-Clip)	1
Vacuum seal VS26	1
Evaporating flask (1 liter)	1
Receiving flask (1 liter)	1
Flyer "List of solvents"	1
Set of required cooling and vacuum tubings	1
Set of required power cables	1
Interface I-300 / I-300 Pro**	1
VacuBox	1
Communications cable. BUCHI COM 6 p	*
Vacuum Pump V-300	1
Recirculating Chiller F-305 / F-308**	*
Communication cables are included	*

\* Optional, according to order code

\*\* According to order code

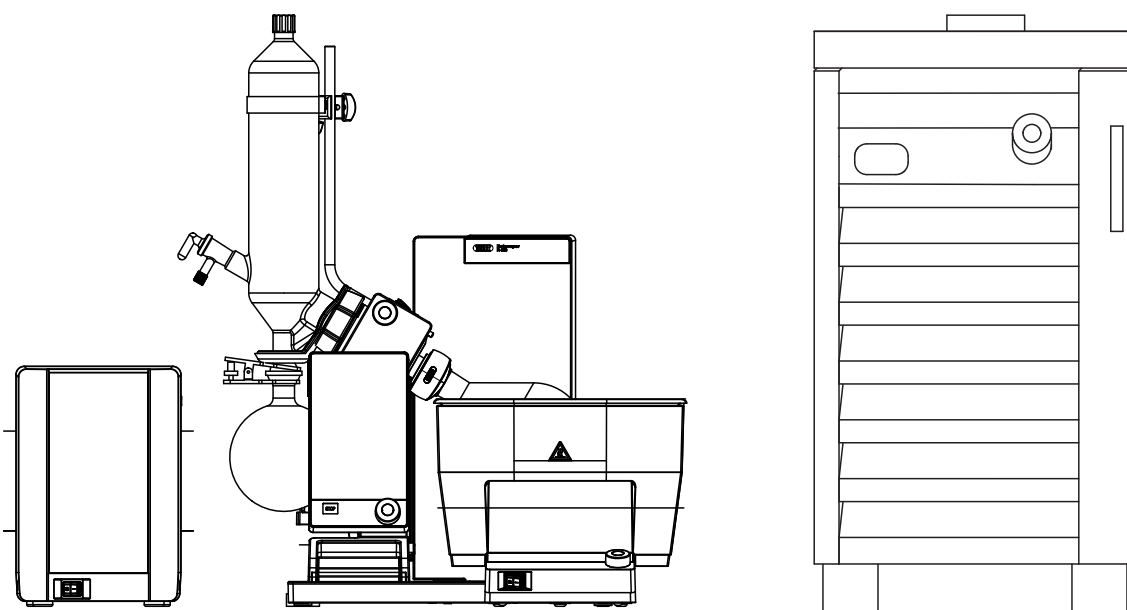

## Technical data

### Rotavapor® R-300

Specification	Value
Dimensions (W x D x H) with glass apparatus V	607 x 429 x 947 mm
Dimension (W x D x H) Shipping box	700 x 590 x 605 mm
Weight	13.5 kg (electric lift) 13.0 kg (manual lift)
Power supply	100 – 240 VAC ± 10%
Power consumption	100 W
Frequency	50/60 Hz
Ingress protection rating	IP21
Overvoltage category	II
Pollution degree	2
Immersion angle	10 – 50°
Vertical adjustment range	220 mm
Limit position detection adjustment range	170 mm (electric lift) 100 mm (manual lift)
Rotation speed range	10 – 280 rpm
Max. flask capacity	3 kg
Approval	CE/CSA

### Heating bath base, B-300

Specification	Value
Dimensions (W x D x H)	183 x 286 x 82 mm
Weight	0.8 kg
Power supply	100 - 120 VAC ± 10% 220 - 240 VAC ± 10%
Frequency	50/60 Hz
Power consumption (with bath)	1500 W
Ingress protection rating	IP21
Approval	CE/CSA

## Heating bath

Specification	Heating Bath B-301	Heating Bath B-305
Dimensions (W x D x H)	225 x 212 x 192 mm	307 x 275 x 202 mm
Weight	2.0 kg	4.2 kg
Power supply	100 - 120 VAC ± 10% 220 - 240 VAC ± 10%	100 - 120 VAC ± 10% 220 - 240 VAC ± 10%
Frequency	50/60 Hz	50/60 Hz
Power consumption	1250 W	1500 W
Heating power	1100 W	1300 W
Ingress protection rating	IP21	IP21
Temperature range	up to 95 °C	up to 220 °C
Evaporating flask maximum size	1000 mL	5000 mL
Maximum bath capacity	2.3 L	5.5 L
Adjustment accuracy	± 1 °C	± 1 °C
Regulation precision	At 60 °C: ± 1 °C At 95 °C: ± 1 °C	At 60 °C: ± 1 °C At 95 °C: ± 1 °C At 180 °C: ± 3 °C At 220 °C: ± 4 °C
Heating fluid	Water	Water/Oil
Approval	CE/CSA	CE/CSA

## Heating bath performance

Heating-up time of Heating Bath B-301 and B-305.

	Water		Oil (Polyalkylenglycole)	
	50 °C	95 °C	180 °C	220 °C
B-301	4 min	13 min		
B-305	8 min	22 min	27 min	37 min

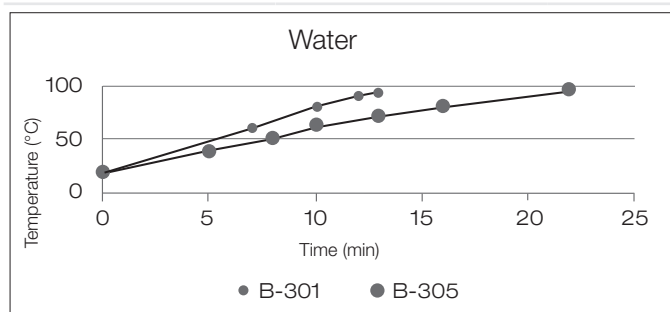

$\Delta T_{70\text{ }^{\circ}\text{C (water)}}$  : B-301 -> 13 min; B-305 -> 22 min



## Special features

### Rotavapor® R-300

Firmware update	With the BUCHI Monitor App and BUCHI Bluetooth Dongle, firmware updates can be easily done by the user at no costs.
End stop positioner	Adjustable via button within a range of 170 mm (electronic) / 100 mm (manual) Prevents glass breakage and damages to heating bath pan
Multifunctional Combi-Clip	Tool for evaporating flask fixation and removal, as well as vapor duct release. Allows one handed flask removal
Immersion angle adjustable	Adjustable within 7-stages enables the use of different flask sizes, adjustable for individual application
Safety stop (electronic lift only)	Automatic operation stop by power failure Lifts flask automatically out of heating bath
2 lift speeds	Moves quickly until 2 cm above close to depth stop, it then moves slowly to depth stop Allows a smooth operation
Earthquake safety	Lug on backside for bath and Rotavapor® Enables fixation on lab bench
Lift height indication	Position is digitally indicated on display of heating bath Allows reproducibility of parameter for future applications
Color code	Green cables indicate BUCHI communication cable, marked with "COM" Allows a simple understanding of set up and easy play & plug
Large top hole V-condenser	Top hole with screw cap (SVL22) Allows easy cleaning of condenser
Ergonomic handle	Electronic and manual version available Allows to conveniently change the position of lift
Display	Rotation speed (actual value), lift position (actual value) and heating bath temperature (set and actual value) displayed on the Heating Bath B-300 Base. Allows user to monitor all parameters at a glance.

## Rotavapor® related patents

Name	Date of application	Number of patent
Condensate trap	2016/06/29	Pending
Rotary evaporator for use in laboratory, has base for holding heat bath, where base includes electrical two-way plug-in connection unit which is detachably connected with plug-in connection unit of heat bath	2005/09/27	DE 202005015235 U1
Height-adjustable support with holder and method of uncoupling the holder	2000/06/26	EP 1 484 112 EP 1 068 903 DE 1 068 903

## Heating Bath B-301 / B-305

Universal use (B-305 only)	Useable for multiple applications up to 220 °C Allows the use of water and oil as a heating media
Overheat protection	Mechanical and electronic over-temperature control Cuts off power when actual exceeds set temperature and by rapid temperature increase

Carry handles	Two integrated laterally ergonomically designed carry handles Allows easy carrying for re-filling or emptying the heating bath, without the risk of burn
Bath guidance	Integrated in Heating Bath B-300 Base Allows an easy positioning of bath along horizontal axe, for individual application
Temperature limit fixation (B-305 only)	Prevents accidental change of set temperature (e.g. when water is used as heating media and maximal temperature is fixed at 95 °C)
Key-button locking functions	To lock the set temperature of the heating bath Prevents accidental change of set conditions during process
Infrared communication	Transition of heating bath data to interface Allows immaculate, fast communication
Kettle connection	Cordless bath Allows easy emptying and refilling of bath without unplugging
Heating Bath B-300 Base extendable	Functional with two different heating baths Allows the use of B-301 or B-305, adequate to application
LCD-display	Digital, displays all operating parameters Indicates set and actual values of heating bath temperature, rotation speed and lift position

## Optional accessories

Protection shield	Special shaped, robust shield for user protection enables handling on evaporating flask while being protected
Top cover for heating bath	To cover B-305 when not in use to safe energy and for less evaporation of heating medium, no drip off, convenient handle prevents burning skin

## Compatibility and communication requirements with R-300

Interface / Vacuum Controller	Compatibility	Communication requirements
I-300 / I-300 Pro	compatible	VacuBox 2x Communication cable. BUCHI COM 6p: 11058705 (0.3 m), 11058707 (1.8 m), 11058708 (5 m) or 11064090 (15 m)
I-100	-	-
V-850 / V-855	-	-
V-800 / V-805	-	-

## Explanation of terms

compatible	Rotavapor® and vacuum controller/interface communicate with each other.
-	Connection not possible

A VacuBox is included when ordering Rotavapor® R-300 with an Interface I-300 or Interface I-300 Pro compatibility pack. Additional features for Rotavapor® R-300 are listed as follows.

## Feature comparison

Features in combination with R-300	I-300 Pro	I-300	I-100	Old vacuum controllers (V-850 / V-855, V-800 / V-805)
Live data charting	•			
Digitally controlled lift position	•			
Data recording	•			
Guided operation (methods)	•			
Automatic ON/OFF rotation speed	•	•		
Automatic and manual up/down lift	•	•		
Display and setting rotation speed	•	•		
Display and setting bath temperature	•	•		
Dynamic distillation (only when connected with Vacuum Pump and Recirculating Chiller)	•	•		
Remote monitoring with Monitor App	•	•		
ECO mode (shuts down Recirculating Chiller and Heating Bath)	•	•		
Automatic foam detection	•	•		
Management from a distance	•	•		

## Accessories – Rotavapor® glass assemblies

The following items have to be purchased in addition to a system that is ordered without glass.

All glass assemblies include a 1 liter receiving flask (corresponding to order code - either without coating, with P+G or P+G-LT), required hoses and a ball joint clamp. Evaporating flask, vacuum seal VS26, vapor duct and condenser holder are not included. All condensers allow feeding of the evaporating flask via stopcock.

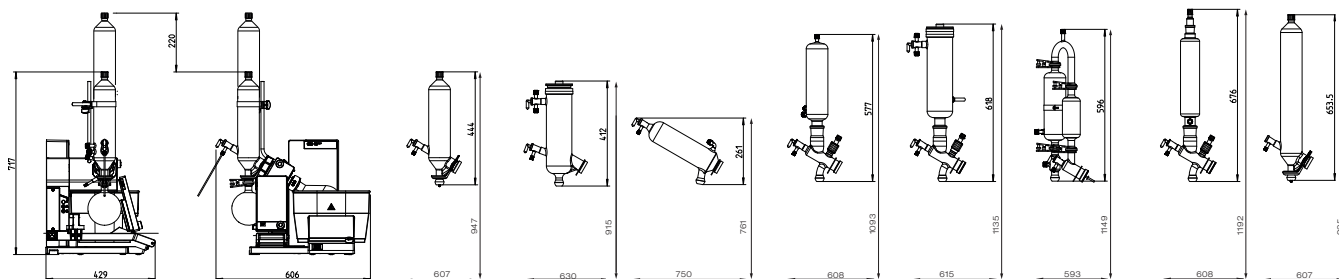

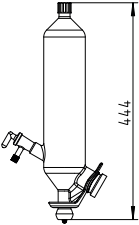
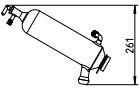
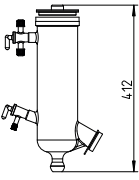
Name	Type / Application	Cooling Surface area (max.)	Order no.
Vertical: V	Vertical condenser <ul style="list-style-type: none"> <li>For standard applications, the most common condenser.</li> <li>Connection for vapor temperature sensor.</li> <li>Automatic distillation with Interface I-300 / I-300 Pro possible.</li> <li>Use of foam sensor possible.</li> </ul>	1500 cm <sup>2</sup>	11062432 11062433 P+G
	BF condenser <ul style="list-style-type: none"> <li>Has the same features as the standard vertical condenser.</li> <li>Supports simultaneous back-feeding and foam prevention.</li> <li>Includes: back-feeding port (SVL22) on the side and valve (048100).</li> <li>Not inclusive: foam sensor.</li> <li>Use of foam sensor and back-feeding possible only with 29/32 vapor duct.</li> </ul>		11074661 11074662 P+G
Diagonal: A	Diagonal condenser <ul style="list-style-type: none"> <li>For standard applications where height is limited</li> </ul>	1500 cm <sup>2</sup>	048168 048169 P+G
			
Cold trap: C	Dry ice condenser <ul style="list-style-type: none"> <li>For distillation of solvents with low boiling points</li> <li>Maximum condensation of vapors</li> <li>No cooling water needed, but i.e. dry ice or ice</li> <li>Use of foam sensor possible</li> </ul>	500 cm <sup>2</sup>	040640 040642 P+G
			

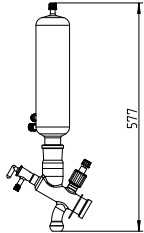
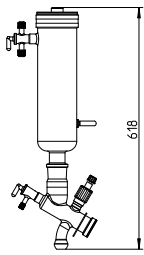
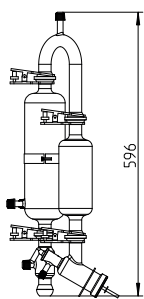
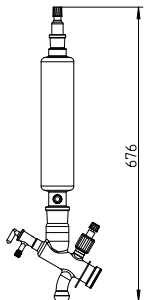
Name	Type / Application	Cooling Surface area (max.)	Order no.
Reflux: S 	Vertical reflux condenser with shut-off valve <ul style="list-style-type: none"> <li>• For combining reflux reaction and distillation</li> <li>• Connection for vapor temperature sensor</li> <li>• Automatic distillation with Interface I-300 / I-300 Pro possible</li> <li>• Use of foam sensor not possible</li> </ul>	1500 cm <sup>2</sup>	048290 048291 P+G-LT
Cold trap reflux: CR 	Dry ice condenser with shut-off valve <ul style="list-style-type: none"> <li>• For combining reflux reaction and distillation</li> <li>• For distillation of solvents with low boiling points</li> <li>• Maximum condensation of vapors</li> <li>• Connection for vapor temperature sensor</li> <li>• No cooling water needed, but i.e. dry ice or ice</li> <li>• Use of foam sensor not possible</li> </ul>	500 cm <sup>2</sup>	048292 048293 P+G-LT
Expansion: E 	Descending condenser with expansion vessel <ul style="list-style-type: none"> <li>• Ideal for distillations exhibiting foaming and "bumping" tendencies/products</li> <li>• Connection for vapor temperature sensor</li> <li>• Automatic distillation with Interface I-300 / I-300 Pro possible</li> </ul>	1500 cm <sup>2</sup>	11061112 11061113 P+G
Double jacket: BY 	Vertical reflux condenser with double jacket for intensive condensation and with shut-off valve <ul style="list-style-type: none"> <li>• Vertical intensive condenser with double jacket and distributor for particularly efficient condensation</li> <li>• For combining reflux reaction and distillation</li> <li>• For particularly efficient and intensive condensation</li> <li>• Connection for vapor temperature sensor</li> <li>• With an additional SJ 29/32 joint on top for flexible expansion</li> <li>• Use of foam sensor not possible</li> </ul>	1300 cm <sup>2</sup>	048297 P+G

Name	Type / Application	Cooling Surface area (max.)	Order no.
High performance: HP	High performance condenser for increased distillation rate <ul style="list-style-type: none"> <li>• Double cooling capacity as standard V condenser</li> <li>• Enables distillation at lower pressure values and higher temperature differences</li> <li>• Reduces emissions of solvents</li> <li>• Reduces the wear of vacuum pump parts</li> </ul> Compatible with: <ul style="list-style-type: none"> <li>• AutoDest sensor</li> <li>• Foam sensor</li> <li>• Vapor temperature sensor</li> <li>• Condensate trap</li> </ul>	3000 cm <sup>2</sup>	11066561
			11066562 P+G

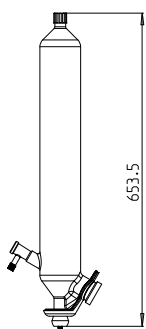

For more information concerning the glass assemblies please check the “Laboratory Evaporation Glassware” brochure.

## Features of the glass assemblies

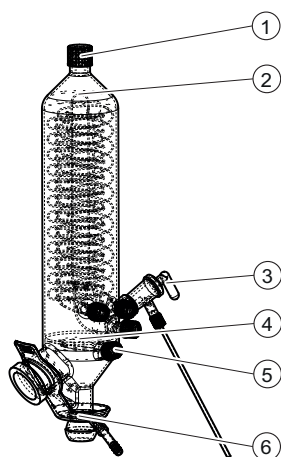

- 1 Top inlet  
For easy cleaning of the condenser
- 2 Inner glass tube  
For reduced chimney effect upon vacuum applications
- 3 Stopcock (available for R-300, R-215, R-210, R-100, R-3; see FAQ)  
Used for aeration and feeding (by using the feeding hose)
- 4 Inner glass plate  
Prevention of solvent back flow
- 5 Connector for sensor  
For measurement of vapor temperature during distillation
- 6 Condensate trap

Characteristics	V	C	A	CR	S	E	BY	HP
Top inlet	• (SVL22; extra large)		•		•	•	•	• (SVL22; extra large)
Inner glass tube	•				•			•
Flask feeding via stopcock possible	•	•	•	•	•	•	•	•
Inner glass plate	•							•
Connector for vapor temperature sensor	•				•	•	•	•
Condenser holder	o <sup>1</sup>	o <sup>1</sup>	o <sup>1</sup>	o <sup>1</sup>	o <sup>1</sup>	•	o <sup>1</sup>	• (048180)
Reflux possibility (part included)				•	•		•	

Characteristics	V	C	A	CR	S	E	BY	HP
Simultaneous back-feeding and foam prevention	○ <sup>2</sup>							
Condensate trap	•							•

○ is optional      • is included      <sup>1</sup> Condenser holder cpl. (048180) is recommended      <sup>2</sup> Only with BF condenser and 29/32 vapor duct

## Accessories

### Heating baths

	Order no.	Image
Heating Bath B-301, 110V, not incl. Base B-300 For up to 1 Liter evaporating flasks. For temperatures up to 95°C. Meant to be used with water as heating media.	11B301002	
Heating Bath B-301, 230V, not incl. Base B-300 For up to 1 Liter evaporating flasks. For temperatures up to 95 °C. Meant to be used with water as heating media.	11B301001	
Heating Bath B-301, 110V, incl. Base B-300 For up to 1 Liter evaporating flasks. For temperatures up to 95 °C. Meant to be used with water as heating media.	11B301102	
Heating Bath B-301, 230V, incl. Base B-300 For up to 1 Liter evaporating flasks. For temperatures up to 95 °C. Meant to be used with water as heating media.	11B301101	
Heating Bath B-305, 110V, not incl. Base B-300, 110V For up to 5 Liter evaporating flasks. For temperatures up to 220 °C. Meant to be used with water or oil as heating media.	11B305002	
Heating Bath B-305, 230V, not incl. Base B-300 For up to 5 Liter evaporating flasks. For temperatures up to 220 °C. Meant to be used with water or oil as heating media.	11B305001	
Heating Bath B-305, 110V, incl. Base B-300 For up to 5 Liter evaporating flasks. For temperatures up to 220 °C. Meant to be used with water or oil as heating media.	11B305102	
Heating Bath B-305, 230V, incl. Base B-300 For up to 5 Liter evaporating flasks. For temperatures up to 220 °C. Meant to be used with water or oil as heating media.	11B305101	

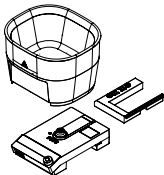
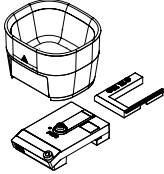

	Order no.	Image
<p>Heating Bath B-305, 110V, for R-21x, incl. Base</p> <p>For up to 5 Liter evaporating flasks. For temperatures up to 220 °C. Meant to be used with water or oil as heating media. Included: Adapter for Rotavapor® R-21x and R-II.</p>	11B305112	
<p>Heating Bath B-305, 230V, for R-21x, incl. Base</p> <p>For up to 5 Liter evaporating flasks. For temperatures up to 220 °C. Meant to be used with water or oil as heating media. Included: Adapter for Rotavapor® R-21x and R-II.</p>	11B305111	

## Heating bath accessories

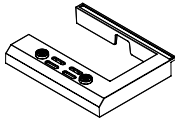
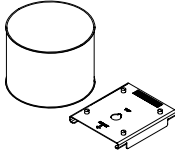
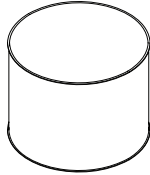
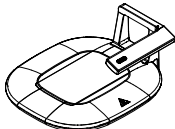
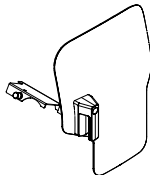
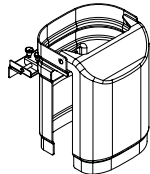
	Order no.	Image
<p>Adapter B-300. For Heating Bath B-305</p> <p>Required when Heating Bath B-305 is used with a Rotavapor® R-210, R-215 or R II. Not compatible with Heating Bath B-301.</p>	11061317	
<p>Dewar accessory, set. Incl. Dewar container and adapter</p> <p>For sample preparation in freeze drying. To be used with dry ice and ethanol / isopropanol / acetone or separately with liquid nitrogen. Compatible with Heating Bath B-300 (not plugged in during operation) and Rotavapor® R-300.</p>	11066662	
<p>Dewar container, not incl. adapter</p> <p>For sample preparation in freeze drying. To be used with dry ice and ethanol / isopropanol / acetone or separately with liquid nitrogen. To be used only with adapter, Heating Bath Base B-300 (not plugged-in during operation) and Rotavapor R-300.</p>	11066645	
<p>Lid. For Heating Bath B-305</p> <p>To save energy and to minimize loss of water when heating bath is not in use.</p>	11059500	
<p>Protection shield, Operator protection for heating bath</p> <p>For Heating Bath B-301 and B-305. Material: 4 mm thick PMMA.</p>	11061402	
<p>Splash shield, Operator protection against splashes</p> <p>For Heating Bath B-301 and B-305. Material: 6 mm thick polycarbonate.</p>	11064768	

	Order no.	Image
Protective cover. For Heating Bath B-300 base Used for protection of the heating bath display.	11064111	

## Further accessories heating baths

	Order no.
Heating bath balls. 450 pcs., PP, Ø10 mm To reduce energy consumption of heating bath and for less evaporation of the heating medium. For temperatures up to 100 °C.	036405

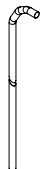

## Tubing



	Order no.
Tubing. FEP, Ø6/8 mm, transparent, per m Use: Vacuum, cooling media.	027900
Tubing. Natural rubber, Ø6/16 mm, red, per m Use: Vacuum.	017622
Tubing. Nyflflex, PVC-P, Ø8/14 mm, transparent, per m 004113	
	
Tubing. PTFE, Ø4.7/5.5 mm, transparent, 330 mm Use: To introduce solvent into evaporating flask during distillation.	000646
Tubing. PTFE, Ø4.7/5.5 mm, transparent, 460 mm Use: To introduce solvent into evaporating flask during distillation.	000643
Tubing. Silicone, Ø6/9 mm, transparent, per m Use: Cooling media.	004133
Tubing. Synthetic rubber, Ø6/13 mm, black, per m 11063244 Use: Vacuum.	

## Insulation tubing

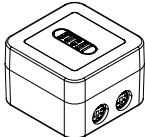
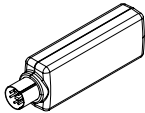
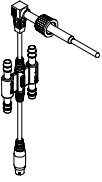
	Order no.	Image
Hose insulation, Kaiflex, 11/23 mm, 1 m, black	028696	

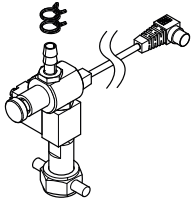
## Further accessories

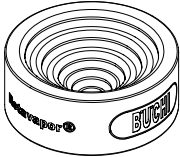
	Order no.	Image
StatusLight cpl., incl. communication cable Indicates the status of the instrument (instrument is ready to use, has an error or is in operation).	11068959	
BUCHI Bluetooth® Dongle, connects instrument to smart-phone via Bluetooth®	11067770	
AutoDest sensor. Incl. cap nut, seal GL14 For automatic distillation. Measures temperature of cooling media and the vapor temperature. Vacuum is adjusted according to cooling capacity of condenser. Meant to be used with the Interface I-300 / I-300 Pro and glass assembly V, HP or S.	11059225	
AutoDry valve In combination with AutoDest sensor for automated distillation of residual solvent. Meant to be used with AutoDest sensor 11059225, Adapter cable for SyncorePlus 11069477, Interface I-300 Pro and S-type condenser.	11074082	
Condensate collector, grey Condenser V and HP, TPE, hose connector Ø8 mm. Collects and drains condensate which may accumulate on the condenser.	11062955	
Condensate collector, green Condenser V and HP, TPE, hose connector Ø8 mm. Collects and drains condensate which may accumulate on the condenser.	11061985	
Cooling water valve, 24 VAC Valve opens cooling water feed during distillation.	031356	

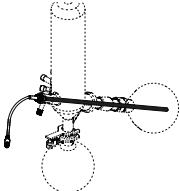
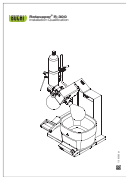
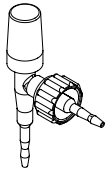
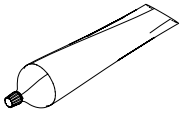
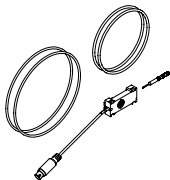
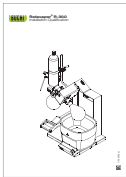
	Order no.	Image
Extraction thimbles, Set. 25 pcs, 43 x 118 mm, cellulose For Soxhlet extraction unit. Working volume: 150 mL	018106	
Flask holder, EPDM, slip free Holder for round-bottom flasks (50 – 5000 mL)	048618	
Flask holders, set. 5 pcs, EPDM, slip free Holder for round-bottom flasks (50 – 5000 mL)	11059916	
Foam sensor. Incl. holder Prevents sample from foaming into the condenser by aeration of system temporarily. Meant to be used with the Interface I-300 / I-300 Pro.	11061167	
IQ/OQ. R-300 en Official BUCHI documents.	11063608	
Back-feeding valve, cpl.	048100	
Lab grease. Glisseal 40 (30 g) To grease joints in order to increase tightness of system.	048197	
Level sensor. Incl. O-ring, cable, rubber band Prevents an overflow in the receiving flask of condenser/secondary condenser. Placed on receiving flask. Meant to be used with the Interface I-300 / I-300 Pro.	11060954	
Repeating OQ. R-300 en Official BUCHI documents.	11063609	

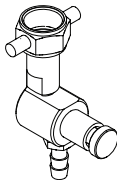
	Order no.	Image
<p>Power plug fixation. For R-300</p> <p>Used to fixate the power plug into Rotavapor®.</p>	11063710	
<p>Set earthquake fastener. Lug for backside</p> <p>To fasten instrument on lab bench.</p>	11062386	
<p>Thread adapter. For vacuum connection, SVL22/GL14</p> <p>Use: To switch vacuum connection from a Rotavapor® to Syncore® vacuum distributor (037686).</p>	040871	
<p>Vacuum connection. Incl. drain valve, hose barb Ø 8 mm, BJ35/20</p> <p>Connection piece for aeration of the system, placed between condenser and receiving flask.</p>	001006	
<p>Vacuum valve. Magnetic valve, 24V/4W, Mini-DIN, 1.5 m</p> <p>Flow valve without flask, meant to be used with a centralized vacuum source or an unregulated vacuum pump. Meant to be used with the Interface I-300 /I -300 Pro.</p>	11060706	
<p>Vapor temperature sensor. Incl. cap nut, seal GL14</p> <p>Measures the vapor temperature inside the system. Meant to be used with the Interface I-300 Pro. Only for vapor temperature, can not be upgraded to AutoDest sensor.</p>	11060707	
<p>Water jet pump. Plastic</p> <p>Used when tap water is used to generate vacuum.</p>	002913	
<p>Water regulation nozzle. Flow regulator, incl. hose clamp, sieve</p> <p>Used when tap water is used to generate vacuum. Reduces water consumption.</p>	011606	
<p>Woulff bottle. 125 mL, P+G, incl. holder</p> <p>For trapping particles and droplets and for pressure equalization.</p>	11059905	

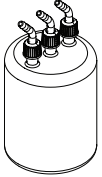
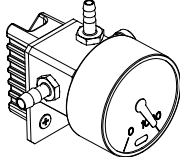
	Order no.	Image
<p>Woulff bottle. 3-neck, 800 mL, P+G.</p> <p>For trapping particles and droplets and for pressure equalization.</p>	025519	
<p>Manometer with needle valve. Incl. vacuum gauge, not incl. holder</p>	047391	

## Accessories for glass assemblies

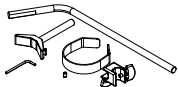
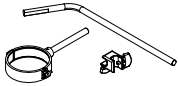
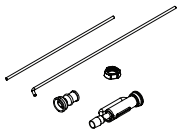
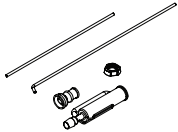
	Order no.	Image
<p>Condenser holder. For glass assembly V/HP/C/S/CR/BY</p> <p>Content: Holding rod, rubber band, cross sleeve.</p>	048180	
<p>Condenser holder. For Glass assembly E</p> <p>Content: Holding rod, bride, cross sleeve.</p>	048181	
<p>Extraction unit Soxhlet, 200 mL, incl. extraction part, reduction part</p> <p>For Soxhlet extraction applications with a Rotavapor® R-300. Meant to be used with glass assembly S. Condenser holder is included.</p>	011744	
<p>Extraction unit Soxhlet, 500mL, incl. extraction part, reduction part</p> <p>For Soxhlet extraction applications with a Rotavapor® R-300. Meant to be used with glass assembly S. Condenser holder is included.</p>	011745	

## Stopcocks

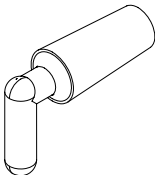
	Order no.	Image
<p>For condenser C/CR, glass, SJ18.8/38</p> <p>For aeration of the system. For cold trap outer part.</p>	040628	

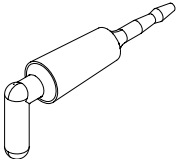
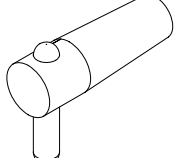
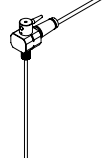
	Order no.	Image
Standard, glass, SJ18.8/38 For aeration of the system.	040627	
Stopcock, Analytic PTFE/25% glass fiber, SJ18.8/38 For feeding of solvents and aerating the system. Less cross-contamination compared to standard stopcock. For applications where grease should be avoided. Content: PTFE stopcock (no tubing included).	11069607	
PTFE, incl. 3-way valve For feeding of solvents and aeration of the system. For applications when grease should be avoided. Used instead of standard-stopcock (040627). Content: Inlet tubing 300mm, backfeed tubing 600mm, cap nut GL10.	11058814	

## Wearing parts

### Vacuum seal

	Order no.
Vacuum seal VS26, PTFE base, NBR O-ring, FDA-complaint	11069167

### Seals

	Order no.
Seal For cap nut GL14, EPDM seal	038225
Seals, set. 10 pcs, for hose barbs GL14, EPDM, black	040029
Seals, set. 10 pcs, for hose barbs GL14, FPM, green	040040
Seals, set. 10 pcs, for hose barbs GL14, silicone, red	040023

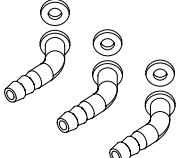
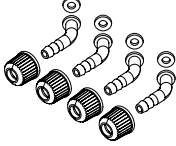
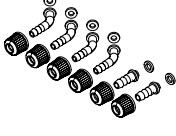

### Hose barbs

	Order no.	Image
Hose barb. Bent, GL14, incl. silicone seal	018916	
Hose barbs, set. 2 pcs, bent (1), straight (1), GL14, silicone seal Content: Hose barbs, cap nuts, seals	041939	

	Order no.	Image
Hose barbs. set. 3 pcs, bent, GL14, silicone seal Content: Hose barbs, seals.	041987	
Hose barbs, set. 4 pcs, bent GL14, silicone seal Content: Hose barbs, cap nuts, seals	037287	
Hose barbs. set. 4 pcs, bent, GL14, EPDM seal Content: Hose barbs, cap nuts, seals.	043129	
Hose barbs, set 4 pcs, bent, GL14, FPM seal Content: Hose barbs, cap nuts, seals.	040295	
Hose barbs. set. 4 pcs, straight, GL14, EPDM seal Content: Hose barbs, cap nuts, seals.	043128	
Hose barbs. set. 4 pcs, straight, GL14, FPM seal Content: Hose barbs, cap nuts, seals.	040296	
Hose barbs, set. 4 pcs, straight, GL14, silicone seal Content: Hose barbs, cap nuts, seals	037642	
Hose barbs. set. 6 pcs, bent (4), straight (2), GL14, silicone seal Content: Hose barbs, cap nuts, seals.	038000	

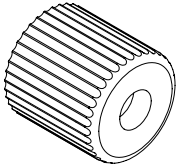

## Miscellaneous wearing parts

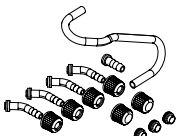
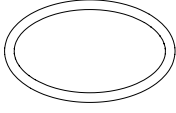
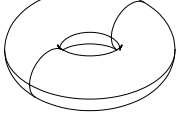
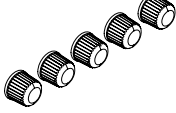
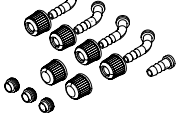
	Order no.	Image
Cap nut. Screw cap with hole GL10	023875	
Cap nuts, set. 10 pcs, screw cap with hole GL14, seal EPDM Content: Cap nuts, seals	041999	
Cap nuts. set. 10 pcs, screw cap with hole, GL14	041956	
Hose, set. Incl. GL14 set, FEP tube 11061756 Used to connect VacuBox and Valve unit/Woulff bottle when both are fixed on the Rotavapor® R-300.	11065373	
O-ring. FKM, 40.9/2.6 mm, for reflux insert	048078	
O-ring. FPM, for cap nut GL10, Ø3.00/2.70 mm	023900	
Screw caps. set. 5 pcs, GL14	040624	
Screwing set, Hose barbs and seals GL14 Content: Hose barbs bent 4 pcs, hose barbs straight 1 pc, cap nuts 4 pcs, screw caps 2 pcs, seals EPDM 3 pcs.	11061921	

## Rotavapor® glass accessories – Vapor ducts



Vapor ducts compatible with VS26 (incl. Combi-Clip)\*

SJ	29/32	24/40	29/42	24/29
For glass assembly V, C, S, E, CR, BY, HP	11062186	11062187	11062464	11062909
For glass assembly A	11062267	11062268	11062269	
For glass assembly V, C, HP (analytical)	11062465	11062466	11062467	
Vapor duct with frit, Ø 26 mm, SJ29/32, incl. Combi-Clip	11057297			
For powder drying. To prevent powder from getting into the condenser. For glass assembly V, C, S, E, BY, HP and CR.				
For high temperatures 29/32, short cpl.	11061837			
Content: Combi clip, vapor duct HT, ring NS 34/32 on 30/32				

\*Single Combi-Clip: 11075539

### Additional glassware

Additional glassware like evaporating flasks, drying flasks, receiving flasks, beaker flasks, Reitmeyer adapters (bump traps) and distillation spiders can be found in the Laboratory Evaporation Glassware brochure.



11595198U en Rotavapor® R-300 02.2025  
Technical data are subject to change without notice  
Quality Systems ISO 9001

---

We are represented by more than 100 distribution partners worldwide.  
Find your local representative at:

[www.buchi.com](http://www.buchi.com)

Quality in your hands

---



11595198U en Rotavapor® R-300 02.2025  
Technical data are subject to change without notice  
Quality Systems ISO 9001

---

We are represented by more than 100 distribution partners worldwide.  
Find your local representative at:

[www.buchi.com](http://www.buchi.com)

Quality in your hands

---